

SUBSCRIBE TO NSK NEWSLETTER ✉

MOTION & CONTROL™
NSK

+ SELF-LUBE®



BRANDS OF **NSK EUROPE**

NSK

RHP bearings



neuweg

Setting the Future in Motion

We are among the leading manufacturers for rolling bearings, linear technology components and steering systems worldwide. We can be found on almost every continent – with production facilities, sales offices and technology centres – because our customers appreciate short decision-making channels, prompt deliveries and local service.

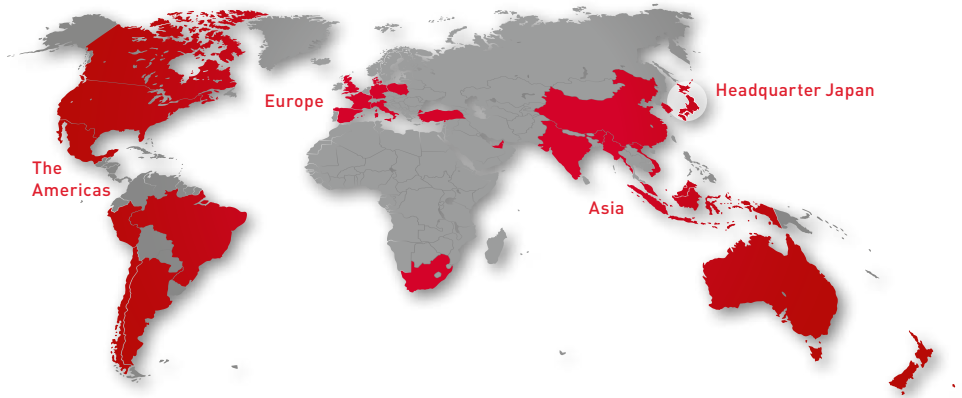

The NSK Company

NSK commenced operations as the first Japanese manufacturer of rolling bearings back in 1916. Ever since, we have been continuously expanding and improving not only our product portfolio but also our range of services for various industrial sectors. In this context our worldwide research and production facilities are linked together in a global network. Here

we concentrate not only on the development of new technologies, but also on the continuous optimisation of quality – at every process stage. Among other things, our research activities include product design, simulation applications using a variety of analytical systems and the development of different steels and lubricants for rolling bearings.

Our most important product: our customers' satisfaction

One thing keeps us moving: we want to help you increase the reliability of your vehicles and equipment, not only with excellent products, but above all with excellent service. Our experienced engineers have a deep understanding of systems – together with you, they work to optimise products and processes and develop solutions for the future. The goal that we are dedicated to every day is ensuring that you remain competitive over the long run.

More about NSK on www.nsk europe.com

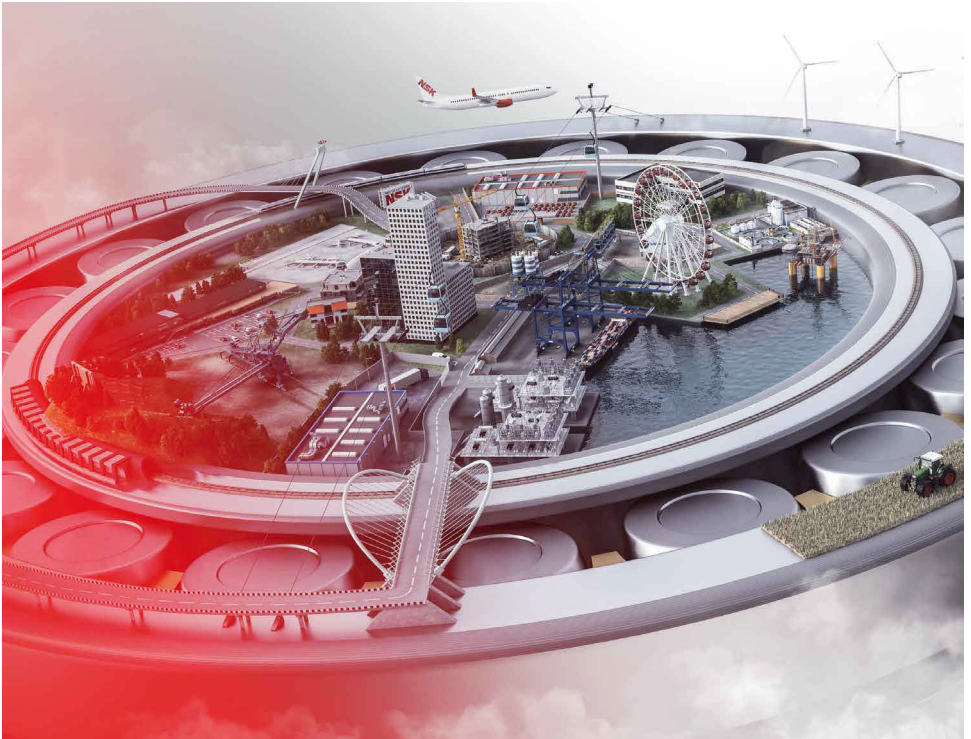



Self-Lube® Bearings

Content

Self-Lube®	5
- Matrix	6
- Part numbering system	8
- Technical information common to all ranges	9
- Load ratios	12
- Technical specification	13
- Bearing tables	21
- Additional products	92
Silver-Lube®	95
- Matrix	96
- Part numbering system	96
- Bearing tables	102
Molded-Oil – Stainless steel units	111
- Matrix	112
- Part numbering system	112
- Technical specification	113
- Bearing tables	114
Life-Lube® (Molded-Oil Inserts in Silver-Lube® Housings)	121
- Matrix	122
- Part numbering system	122
- Technical specification	123
- Bearing tables	126
Special Products and Bearing Solutions	137
- Additional products	138
- HLT Self-Lube®	138
- Special housing options	138
Interchange list	139
- Common engineering unit conversion tables	
Conversion tables	147
- Part number interchange list	



Self-Lube® General Technical Specification

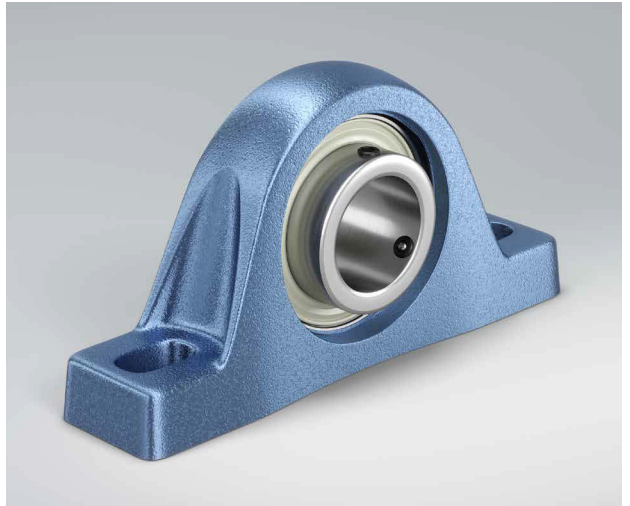

Standard unit references

Insert Type

Housing Type

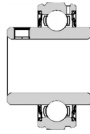

1000G

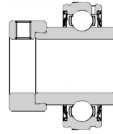

1000DECG

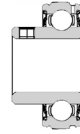

1200G

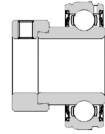

1200ECG

Cast iron one piece



Page

78

80

81

82

22

NP

NP-DEC

NP-A

NP-EC

28

SL

SL-DEC

SL-A

SL-EC

30

MP

34

SNP

SNP-DEC

SNP-A

SNP-EC

34

CNP

CNP-DEC

CNP-A

CNP-EC

36

SF

SF-DEC

SF-A

SF-EC

38

MSF

42

SFT

SFT-DEC

SFT-A

SFT-EC

44

MSFT

48

LFTC

LFTC-DEC

LFTC-A

LFTC-EC

50

FC

FC-DEC

FC-A

FC-EC

52

MFC

54

ST

ST-DEC

ST-A

ST-EC

56

MST

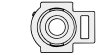

60

BT

BT-A

BT-EC

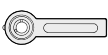

62

SLC

SLC-DEC

SLC-A

SLC-EC



64

MSC



66

SCHB

66

SCH

Pressed steel two piece

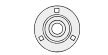

68

SLFE

SLFE-DEC

SLFE-A

SLFE-EC



70

SLFT

SLFT-DEC

SLFT-A

SLFT-EC



72

SLFL

SLFL-DEC

SLFL-A

SLFL-EC



74

LPB

LPB-DEC

LPB-A

LPB-EC



76

LPBR

LPBR-DEC

LPBR-A

LPBR-EC

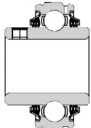

T1000G

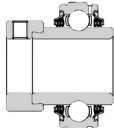

T1000DECG

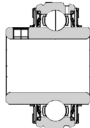

1000GFS

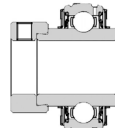

1000DECGFS

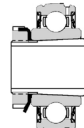

1000-KG

86	88	89	90	84	Page
TNP	TNP-DEC	NP-FS	NP-DECFS	NP1000-K	26
TSL	TSL-DEC	SL-FS	SL-DECFS		
TMP		MP-FS		MP1000-K	32
TSNP	TSNP-DEC	SNP-FS	SNP-DECFS		
TCNP	TCNP-DEC	CNP-FS	CNP-DECFS		
TSF	TSF-DEC	SF-FS	SF-DECFS		
TMSF		MSF-FS		MSF1000-K	40
TSFT	TSFT-DEC	SFT-FS	SFT-DECFS		
TMSFT		MSFT-FS		MSFT1000-K	46
TLFTC	TLFTC-DEC	LFTC-FS	LFTC-DECFS		
TFC	TFC-DEC	FC-FS	FC-DECFS		
TMFC		MFC-FS			
TST	TST-DEC	ST-FS	ST-DECFS		
TMST		MST-FS		MST1000-K	58
TBT		BT-FS			
TSLC	TSLC-DEC	SLC-FS	SLC-DECFS		
TMSC		MSC-FS			
TSCHB		SCHB-FS			
TSCH		SCH-FS			
TSLFE	TSLFE-DEC	SLFE-FS	SLFE-DECFS		
TSLFT	TSLFT-DEC	SLFT-FS	SLFT-DECFS		
TSLFL	TSLFL-DEC	SLFL-FS	SLFL-DECFS		

Standard Self-Lube® insert references

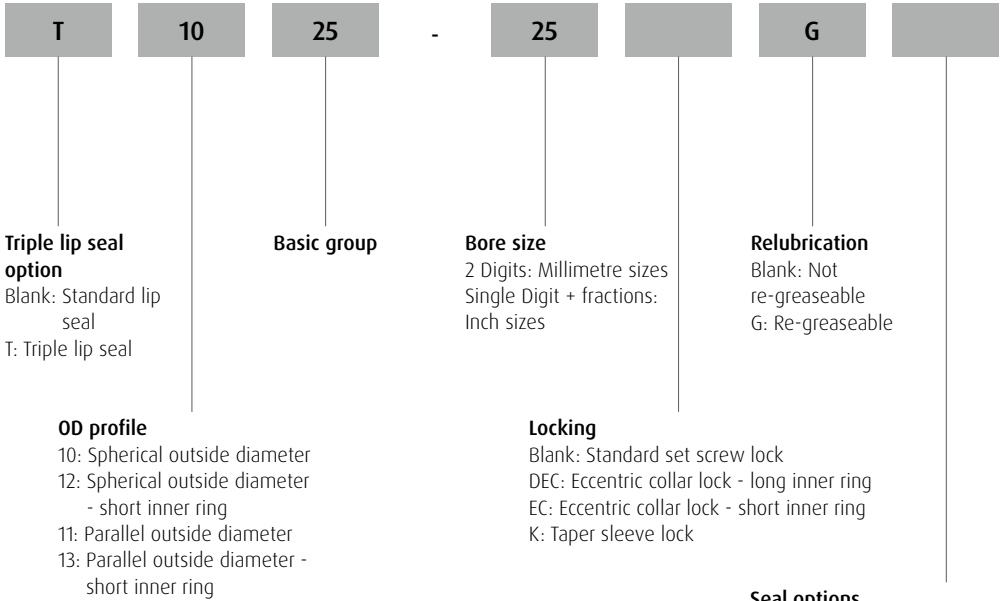

List of common prefixes and suffixes

Prefixes

- B Unit or bearing insert supplied without locking collar.
- J Grease groove on the side of the bearing insert nearest to the locking device.
- T Triple lip sealed bearing insert.

Suffixes

- A Unit fitted with set screw lock insert with flush inner ring on one side.
- C4 Radial clearance greater than C3.
- CG Parallel outside diameter insert with grease groove and snap ring fitted.
- DEC Eccentric collar lock with extended inner ring.
- DL Double locking inner ring – 4 set screws (2 each end).
- EC Eccentric collar lock with flush inner ring on one side.
- FS Bearing insert fitted with flinger seals.
- G Bearing insert having relubrication facility.
- HLT High and low temperature bearing insert.
- K Bearing insert with tapered bore.
- L Larger than normal unit for the basic bore size.
- P Housing fitted with 1/8" BSP grease nipple (standard is 1/4" UNF).
- R Smaller than normal unit for the basic bore size.

Self-Lube® product range

NSK manufactures several ranges of mounted units. These include Self-Lube®, our recognised standard, and recently introduced ranges such as Silver-Lube®, Life-Lube® and Molded-Oil units. In each type, there are two basic components, the insert and the housing.

Self-Lube® bearing inserts

The Self-Lube® bearing insert, commonly known as a wide inner ring bearing, is designed to suit the wide range of housings offered by NSK in the Self-Lube® bearing family and is also suitable for applications where the user's own housing is preferred.

They are basically deep-groove ball bearings, to the popular 6200 series configuration, with integral design features making them more functional and versatile than standard ball bearings. The radial internal clearance is C3 for standard bearing inserts and bearings can be offered with either parallel or spherical outside diameter outer rings with the latter being the type fitted in the bearing unit. The integral design features of the bearing insert, such as shaft locking, sealing and lubrication, are explained in the following pages.

Self-Lube® bearing units

The range of Self-Lube® bearing units offers a wide choice of cast iron, pressed steel, synthetic rubber, thermoplastic or stainless steel housings fitted with spherical outside diameter Self-Lube® bearing inserts. They will generally accommodate initial housing misalignment up to 1.7° radians but are not recommended for running misalignment in excess of 0.06° radians.

The general housing types are pillow blocks, flange units, take-up units, cartridge units and hanger units. Choice is very much determined by the requirements of the application, although the aesthetic appearance of the machine design is often an important consideration. Self-Lube® units have been designed to meet the needs of both criteria.

- Cast iron unit castings are made from high-quality cast iron, and finished on unmachined surfaces with an electrostatic air-drying paint.
- Pressed steel housings are made from mild steel strip, and are zinc plated.
- Thermoplastic housings are moulded in highgrade PBT, a high quality thermoplastic polyester resin.
- Stainless steel housings are made from austenitic stainless steel castings (SCS13).

Additional products

NSK recognises the need for 'tailor made' solutions and is always willing to help customers who have a requirement for something out of the ordinary.

Dynamic load ratings

The NSK dynamic load ratings given in this catalogue and the relationship between these and bearing fatigue life are based on ISO standard 281.

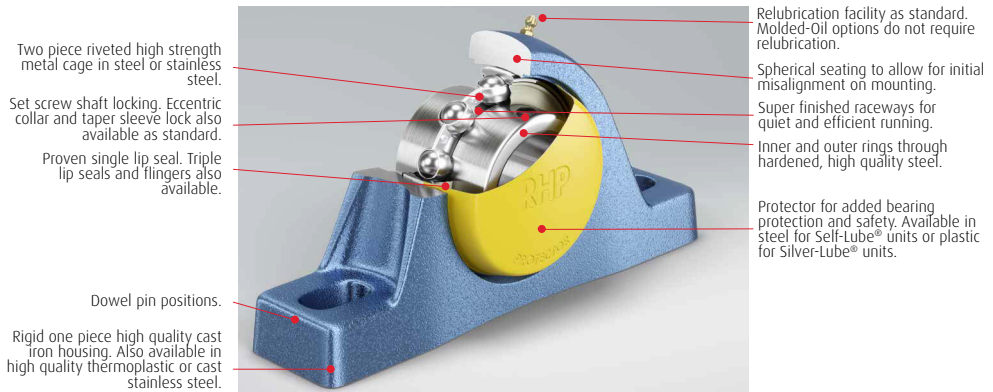

Bearing load ratings and endurance

Basic dynamic radial load rating C_r

This is defined as the load that can be applied to the bearing to give a basic L_{10} rating life of one million revolutions. This is the life associated with 90% reliability which has been found by experience to be acceptable for normal engineering bearing applications. The majority of the bearings attain a much longer life and the median life is approximately five times the L_{10} life. Ratings for each series are given in the bearing tables and are used to calculate life for radial loads of constant magnitude and direction.

Equivalent dynamic radial load P_r

For applications where axial and radial loads are present they must be converted into a single equivalent radial load P_r and calculated as follows, where:

- F_r = actual radial load (N)
- F_a = actual axial load (N)
- Y = axial factor from table 18.2
- C_{or} = basic static load rating
- C_r = dynamic radial load rating
- f_o = axial load factor

Note: Axial load F_a must not exceed $0.5 C_{or}$.
Select f_o from table 18.1 for the appropriate bearing insert.

Calculate $\frac{f_o F_a}{C_{or}}$ and obtain the value of Y from table 18.2.
Calculate P_r where:

$$P_r = F_r \quad \text{or} \\ P_r = 0.56 F_r + Y F_a$$

Use whichever P_r value is the greatest.

Relationship between load and life

Having determined the equivalent load P_r the nominal L_{10} bearing life is calculated as follows:

$$L_{10} \text{ life in hours} = \left(\frac{C_r}{P_r} \right)^3 \cdot \frac{10^6}{60 n}$$

where n = bearing operating speed (rev/min).

Alternatively, by using the loading ratio $\frac{C_r}{P_r}$ the bearing L_{10} life can be estimated by reading off directly from the tables on page 12 under the appropriate speed column.

Basic static load rating C_{or}

This value is calculated in accordance with ISO standard 76. Ratings for each series are given in the bearing tables.

Static equivalent radial load P_{or}

When static axial and radial loads are applied to a bearing these must be converted to an equivalent static radial load P_{or} where:

F_{or} = actual static radial load (N)

F_{oa} = actual static axial load (N)

Calculate P_{or} where:

$$P_{or} = F_{or} \quad \text{or} \\ P_{or} = 0.6 F_{or} + 0.5 F_{oa}$$

Use whichever P_{or} value is greater, but this value **should not exceed** the bearing static radial load rating C_{or} .

Service factors

It is customary when calculating bearing life to include application factors which allow for fluctuations in loading that occur in service, and from experience the following may be used as a guide.

For steady and light shock loads multiply load by 1.2 to 1.5.

For moderate shock loads multiply load by 1.7 to 2.0.

When selecting the size of bearing for a given load, the calculated life should conform to the L_{10} lives shown in the next column:

- Machines in use 8 hours/day - not fully utilised - 10,000 to 20,000 hours
- Machines in use 8 hours/day - fully utilised - 20,000 to 30,000 hours.
- Machines in use 24 hours/day - 40,000 to 80,000 hours.
- Machines in seasonal use - 4,000 to 8,000 hours.

Limiting loads

The axial load F_{oa} must not exceed half the basic static load rating C_{or} . Housing strengths must also be considered as a limiting factor - see detail on page 17.

Table 18.1

Basic bearing insert	f_o
1017	13.1
1020	13.1
1025	13.9
1030	13.8
1035	13.8
1040	14.0
1045	14.1
1050	14.4
1055	14.3

Table 18.2

Basic bearing insert	f_o	$\frac{f_o F_a}{C_{or}}$	Y
1017	14.3	0.172	2.30
1020	14.4	0.345	1.99
1025	14.4	0.689	1.71
1030	14.7	1.03	1.55
1035	14.6	1.38	1.45
1040	14.7	2.07	1.31
1045	14.5	3.45	1.15
1050	13.6	5.17	1.04
1055	14.3	6.89	1.00

Examples of bearing calculations

Example 1

What nominal life can be obtained from NP55 with a steady radial load $F_r = 3900\text{N}$ at speed of 1500 rev/min? The dynamic load rating C_r of the unit from page 23 is 43500N. Since the bearing is not subject to axial load the equivalent load $P_r = F_r$ according to the formula on page 10. Therefore applying the service factor of 1.2 for a steady load.

$$P_r = F_r \cdot 1.2 = 3900 \cdot 1.2 = 4680\text{N}.$$

From page 10,
 L_{10} life in hours

$$\begin{aligned} &= \left(\frac{C_r}{P_r} \right)^3 \cdot \frac{10^6}{60 \times 60} \\ &= \left(\frac{43500}{4680} \right)^3 \cdot \frac{10^6}{1500 \times 60} \\ &= 8923 \text{ hours} \end{aligned}$$

Alternatively, using the loading ratio tables on page 12 an approximate life can be obtained by locating the nearest $\frac{C_r}{P_r}$ value in the appropriate rev/min column.

$$\text{Therefore } \frac{C_r}{P_r} = \frac{43500}{4680} = 9.29$$

Under the 1500 rev/min column the nearest $\frac{C_r}{P_r}$ value is 9.65 which gives an approximate life of 10000 hours.

Example 2

With a radial load $F_r = 2940\text{N}$ and an axial load $F_a = 1470\text{N}$ at 300 rev/min with moderate shock present, what nominal L_{10} life can be obtained from unit reference SF40? The dynamic radial load rating C_r of the unit from page 37 is 32500N and the static load rating C_{or} is 19900N. Since the bearing is subject to radial and axial loads we have to establish the equivalent load P_r according to page 10.

First, using the left hand table at the foot of page 10, we establish the value of $\frac{f_0 F_a}{C_{or}}$

$$\frac{f_0 F_a}{C_{or}} = \frac{14.0 \cdot 1470}{19900} = 1.03$$

Using this value in the right hand table at the foot of page 10, we establish a value for $Y = 1.55$.

From page 10 we then calculate the value of P_r

$$P_r = 2940\text{N}$$

or

$$P_r = 0.56 (2940) + 1.55 (1470) = 3925\text{N}$$

Using the greater value of P_r and applying an application factor of 1.7 (page 10) for moderate shock loads:

$$\begin{aligned} P_r &= 3925 \cdot 1.7 \\ &= 6673\text{N} \end{aligned}$$

From page 10:

$$\begin{aligned} &L_{10} \text{ life hours} \\ &= \left(\frac{C_r}{P_r} \right)^3 \cdot \frac{10^6}{60n} \\ &= \left(\frac{32500}{6673} \right)^3 \cdot \frac{10^6}{60 \times 300} \\ &= 6418 \text{ hours} \end{aligned}$$

Alternatively, using the loading ratio tables on page 12, an approximate life can be obtained by locating the nearest C_r/P_r value in the appropriate rev/min column. Therefore, $C_r/P_r = 32500/6673 = 4.87$. Under the 300 rev/min column on page 12, calculated value of 4.87 is approximately mid-way between table values of 4.48 and 5.13. By interpolation, this gives an approximate life of 6250 hours.

Housing strength

To check the housing strength for example 2 when the axial load $F_a = 1470\text{N}$ and applying an application factor of 1.7 then: Axial load = $1470 \cdot 1.7 = 2499\text{N}$

From page 17 we see that the maximum axial loads for the above unit are:

0.45 C_{or} in one direction, and

0.25 C_{or} in the opposite direction.

Calculating these two maximum axial loads that may be applied to housing:

$$0.45 \cdot 19900 = 8955\text{N}$$

$$0.25 \cdot 19900 = 4975\text{N}$$

From the above it can be seen that the housing will support the axial load of 2499N in either direction. Therefore, the unit above is satisfactory for the loading conditions stated.

Note It is advisable to shoulder the shaft for high axial loads.

Loading ratios

Life estimation for ball bearings for different C_r/P_r ratios and speeds

L_{10} life (hours)	Speed: rev/min								
	25	50	100	150	200	300	500	750	1000
100					1.06	1.22	1.45	1.65	1.82
500		1.14	1.45	1.65	1.82	2.08	2.47	2.82	3.11
1000	1.14	1.44	1.82	2.08	2.29	2.62	3.11	3.56	3.91
1500	1.31	1.65	2.08	2.38	2.62	3.00	3.56	4.07	4.48
2000	1.45	1.82	2.29	2.62	2.88	3.30	3.91	4.48	4.93
3000	1.65	2.08	2.62	3.00	3.30	3.78	4.48	5.13	5.65
5000	1.96	2.47	3.11	3.56	3.91	4.48	5.32	6.08	6.70
7500	2.24	2.82	3.56	4.07	4.48	5.13	6.08	6.96	7.66
10000	2.47	3.11	3.91	4.48	4.93	5.65	6.70	7.66	8.43
19500	2.82	3.56	4.48	5.13	5.65	6.46	7.66	8.77	9.65
20000	3.11	3.91	4.93	5.65	6.21	7.11	8.43	9.65	10.60
30000	3.56	4.48	5.65	6.46	7.11	8.14	9.65	11.10	12.20
40000	3.91	4.93	6.21	7.11	7.81	8.96	10.60	12.20	13.40
60000	4.48	5.65	7.11	8.14	8.96	10.30	12.20	13.90	15.30
80000	4.93	6.21	7.81	8.96	9.83	11.30	13.40	15.30	16.80

Life estimation for ball bearings for different C_r/P_r ratios and speeds

L_{10} life (hours)	Speed: rev/min								
	1500	2000	3000	4000	5000	6000	8000	10000	
100	2.08	2.29	2.62	2.88	3.11	3.30	3.63	3.91	
500	3.56	3.91	4.48	4.93	5.32	5.65	6.21	6.69	
1000	4.48	4.93	5.65	6.21	6.70	7.11	7.81	8.43	
1500	5.13	5.65	6.46	7.11	7.65	8.15	8.96	9.65	
2000	5.65	6.21	7.11	7.81	8.43	8.96	9.83	10.60	
3000	6.46	7.11	9.14	8.96	9.65	10.30	11.30	12.20	
5000	7.66	8.43	9.65	10.60	11.50	12.20	13.40	14.40	
7500	8.77	9.65	11.10	12.20	13.10	13.90	15.30	16.50	
10000	9.65	10.60	12.20	13.40	14.50	15.30	16.80	18.20	
19500	11.10	12.20	13.90	15.30	16.50	17.50	19.30	20.80	
20000	12.20	13.40	15.30	16.80	18.50	19.30	21.20	22.90	
30000	13.90	15.30	17.50	19.30	20.80	22.10	24.30	26.20	
40000	15.30	16.80	19.30	12.20	22.90	24.30	26.70	28.80	
60000	17.50	19.30	22.10	14.30	26.20	27.80	30.70	33.00	
80000	19.30	21.20	24.30	16.70	28.80	30.70	33.70	36.30	

Self-Lube[®] product range

Under the heading of Self-Lube[®] bearings there are two basic products: The Self-Lube[®] bearing insert and the Self-Lube[®] bearing unit.

Self-Lube[®] bearing unit

The range of Self-Lube[®] bearing units offers a wide choice of cast iron, pressed steel or synthetic rubber housings fitted with the full range of spherical outside diameter Self-Lube[®] bearing inserts. They will accommodate initial housing misalignment up to 1.7° radians but are not recommended for running misalignment in excess of 0.06° radians.

The general housing types are pillow blocks, flange units, take-up units, cartridge units and hanger units. Choice is very much determined by the requirements of the application, although the aesthetic appearance of the machine design is often an important consideration. Self-Lube[®] units have been designed to meet the needs of both criteria.

The castings are made from high-quality cast iron, and finished on unmachined surfaces with an electrostatic air-drying paint.

Pressed steel housings are made from mild steel strip, and are zinc plated. Rubber housings are moulded in antistatic nitrile rubber.

HLT Self-Lube[®]

HLT Self-Lube[®] inserts are designed to operate reliably at extreme temperatures, within the range -40°C to +180°C. HLT inserts are available across the entire Self-Lube[®] range.

HLT inserts have:

- C5 internal clearance
- High performance Mobil grease
- Silicone rubber seals
- Optional protector
- Relubrication facility

Self-Lube[®] Protector

The Self-Lube[®] Protector is designed to protect the machine operator from the dangers of rotating shaft ends and the external surfaces of the bearing from contamination.

The protector is made from good quality mild steel and coated with enamel paint making it robust, attractive and long lasting. It is easy to fit and can be removed without breakage or deformation thus allowing it to be refitted time after time.

Standard Self-Lube[®] inserts with spherical outside diameters have a 'groove' in the outer ring on the opposite side from the grease groove. The protector has two claws which locate through the casting loading slots into the 'groove' in the outer ring. This provides a very secure lock and makes the Protector difficult to dislodge. The user of Self-Lube[®] units is not required to purchase special bearings or provide any additional locking device in order to obtain this secure safety feature.

The Protector can be removed by inserting a form of lever device into a small hole in one of the claws and exerting slight pressure outwards. This disengages the claw from the outer ring 'groove'. A replaceable cover for the hole is provided.

Sealing and Lubrication

Relubrication of Self-Lube® Bearings

NSK Self-Lube® Bearings are factory charged with the correct amount of grease and do not require a further grease charge when being fitted.

Relubrication is not normally necessary except when operating at extremes of temperature, speed and loading, or where excessive wet or dirty conditions exist.

The relubrication frequency varies with the type and quality of grease used as well as the operating conditions. Therefore, it is difficult to establish a general rule, but under ordinary operating conditions, it is desirable that grease be replenished before one third (1/3) of its calculated life elapses. It is necessary, however, to take into consideration such factors as hardening of grease in the oil hole, making replenishment impossible, or deterioration of grease due to oxidation while the machine is running.

The table shows standard relubrication frequencies. Irrespective of the calculated life of the grease, this list takes into consideration such factors as the rotational speed of the bearings, operating temperatures and environmental conditions, with a view to safety.

The performance of a bearing is greatly influenced by the quantity of grease. In order to avoid overfilling, it is advisable to replenish the grease while the machine is in operation. Continue to insert grease until a little oozes out from beneath the sealing lip on the inner ring for optimum performance.

All standard Self-Lube® bearing units have 1/4"-28UNF grease nipples, except for the FC series units which have M5 x 0.8mm pitch grease nipples.

Lubrication

Unit	Unit temperature range	Grease	Supplier
Standard insert	-20°C to +110°C	Gadus S2 V100 2	Shell
HLT insert	-40°C to +180°C	SHC Polyrex 102 EM	Mobil

Standard relubrication frequencies

Type of unit	dn Value	Environmental conditions	Operating temp °C, °F		Relubrication frequency	
			°C	°F	Hours	Period
Standard	40000 and below	Ordinary	-15 to +80	+5 to +176	1500 to 3000	6 to 12 mo.
Standard	70000 and below	Ordinary	-15 to +80	+5 to +176	1000 to 2000	3 to 6 mo.
Standard	70000 and below	Ordinary	+80 to +100	+176 to +212	500 to 700	1 mo.
HLT	70000 and below	Ordinary	+100 to +130	+212 to +266	300 to 700	1 mo.
HLT	70000 and below	Ordinary	+130 to +180	+266 to +356	100 to 300	1 wk.
HLT	70000 and below	Ordinary	-60 to +80	-76 to +176	1000 to 2000	3 to 6 mo.
Standard	70000 and below	Very dusty	-15 to +100	+5 to +212	100 to 500	1 wk. to 1 mo.
Standard	70000 and below	Exposed to water splashes	-15 to +100	+5 to +212	30 to 100	1 day to 1 wk.

dn = bore diameter (mm) · speed (rpm)

Single Lip Seal

The S-type seal, which is firmly secured in the bearing outer ring, comprises a nitrile rubber sealing element (black in colour) bonded to a strong steel former. The flexible sealing lip contacts the fine ground finish of the inner ring to give low friction with effective sealing.

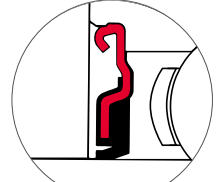

Single lip seal (standard)

Flinger seal

Where extra protection is required without loss of bearing catalogue speed, the 'Flinger seal' is ideal. It consists of a steel flange to which is bonded a flexible nitrile sealing lip. They are offered for the 1000G and 1000DECG types and are identified with the suffix FS (e.g. 1025-25GFS, NP25FS). The flinger is fitted to the inner ring.

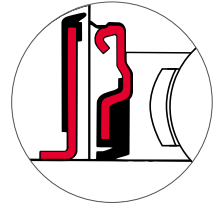

Single lip seal + flinger seal

Triple lip seal

For applications with a high degree of contamination, the specially developed RHP triple lip seal is recommended. It consists of a one-piece moulded nitrile seal with three sealing lips, bonded to a protective steel outer pressing which is strongly secured in the outer ring making a highly efficient sealing arrangement. It is not recommended for high speeds. See pages 86 to 88.

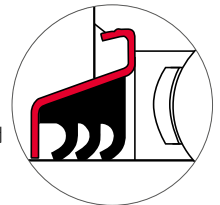

Triple lip seal

Shaft locking arrangements

Set screw lock

This locking arrangement consists of two knurled cup-point, self-locking, socket-head set screws fitted in the extended inner ring.

For normal loads and moderate speeds simply mount the bearing unit into position and tighten down the set screws to the recommended torque value.

Additional security can be achieved by spot drilling the shaft to accommodate the set screw point. When spot drilling, first remove the set screw and locate the position on the shaft. Select a drill the size of the inner ring threads minor diameter, and drill through this hole into the shaft to the depth of the drill point.

Replace the set screw and tighten onto the shaft in the normal manner.

The recommended tightening torques for the set screws are given on page 16.

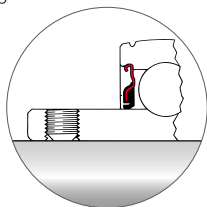

Set screw lock

Eccentric collar lock

This type of lock consists of an eccentric diameter formed on the extended inner ring of the bearing which engages a similarly formed eccentric diameter in the bore of a separate collar. Locking is achieved by turning the collar in the direction of the shaft rotation until the eccentric diameters of both collar and inner ring are fully engaged. The collar is provided with a blind hole to facilitate tightening when locking the bearing to the shaft. The set screw when tightened to the recommended torque values on page 16 prevents the collar 'backing off' in service.

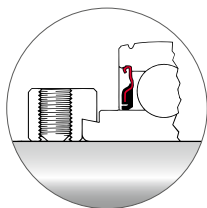

Eccentric collar lock

Taper sleeve lock

This locking arrangement, which incorporates a standard taper adapter sleeve, locknut and lock washer, is recommended when a positive concentric (shaft) lock is required.

When fitting the bearing to the shaft, care must be taken to ensure that the locknut is not over-tightened as this can eliminate the bearing internal clearance, resulting in premature failure. A lockwasher is provided which prevents the locknut 'backing off' when one of the tabs is engaged with the corresponding notch in the locknut. (See below for fitting instructions).

The recommended tightening torques for the locknuts are given on page 16.

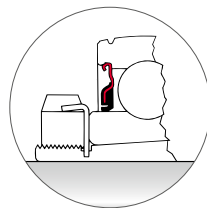

Taper sleeve lock

Mounting Self-Lube® adapter sleeve units

- First bolt the Self-Lube® housing to the equipment and clean the shaft and sleeve bore of any oil or grease.
- Position the shaft within the unit and tighten up the locknut by hand. If the sleeve assembly turns on the shaft tap the sleeve into the bearing to give a positive grip. Tighten locknut to recommended torque value given on page 16.
- Where torque spanner facilities are not available a blunt drift and small hammer may be used to tighten the nut.
- Check that the bearing rotates freely, to ensure that the internal clearance has not been totally removed and that preload has been avoided.
- Finally, secure the nut with the appropriate tab on the locking washer. Tighten the nut slightly if necessary but never back the nut off.
- After 100 hours running it is advisable to check the tightness of the locknut.

Set screw thread and tightening torques

Set screw thread and size

Basic bearing insert reference	Series			
	1000G, 1100, 1200G, 1300		1000DECG, 1100DEC, 1200ECG, 1300EC	
	Inch bore diameters	Metric bore diameters	Inch bore diameters	Metric bore diameters
1017	¼UNF	M6 x 0.75	¼UNF	M6 x 0.75
1020	¼UNF	M6 x 0.75	¼UNF	M6 x 0.75
1025	¼UNF	M6 x 0.75	¼UNF	M6 x 0.75
1030	¼UNF	M6 x 0.75	¼UNF	M6 x 0.75
1035	⅜UNF	M8 x 1.00	⅜UNF	M8 x 1.00
1040	⅜UNF	M8 x 1.00	⅜UNF	M8 x 1.00
1045	⅜UNF	M8 x 1.00	⅜UNF	M8 x 1.00
1050	⅝UNF	M10 x 1.25	⅝UNF	M10 x 1.25
1055	⅝UNF	M10 x 1.25	⅝UNF	M10 x 1.25
1060	⅝UNF	M10 x 1.25	⅝UNF	M10 x 1.25
1065	⅝UNF	M10 x 1.25	⅝UNF	M10 x 1.25
1070	7/16UNF	M12 x 1.50	7/16UNF	M12 x 1.50
1075	7/16UNF	M12 x 1.50	7/16UNF	M12 x 1.50
1080	7/16UNF	M12 x 1.50	-	-
1085	7/16UNF	M12 x 1.50	-	-
1090	½UNF	M12 x 1.50	-	-
3095	⅝UNF	M16 x 1.50	-	-

Set screw tightening torques and maximum axial loads

Set screw size	Socket/Allen key size (across flats)	Recommended maximum tightening torque		Set screw maximum axial load	
		newton metres (Nm)	lbf-inches	newtons (N)	lbf
¼UNF	⅛"	6.8	60	2500	560
⅜UNF	⅜"	12.4	110	3500	785
⅝UNF	⅜"	22.6	200	4500	1010
7/16UNF	7/32"	31.6	280	7500	1685
½UNF	¼"	45.2	400	9000	2025
⅝UNF	⅜"	53.9	477	15000	3370
M6 x 0.75	3mm	5.7	50	2500	560
M8 x 1.00	4mm	12.4	110	3500	785
M10 x 1.25	5mm	27.1	240	5000	1235
M12 x 1.50	6mm	38.4	340	8000	1800
M16 x 1.50	8mm	53.9	477	15000	3370

Note: For axial loads in excess of the values listed a shouldered shaft against the face of the inner ring is recommended.

Recommended tightening torques for adapter sleeve units

Sleeve bore size	Tightening torques	
	Nm	lbf-inches
20mm, ¾"	30	265
25mm, 1⅜", 1"	40	355
30mm, 1½", 1⅜"	50	440
35mm, 1¼", 1⅜"	60	530
40mm, 1⅞", 1½"	65	575
45mm, 1⅞", 1⅝"	75	660
50mm, 1⅞", 2"	85	750

Mounting instructions for Self-Lube® bearing units

Self-Lube® set screw locking arrangement units

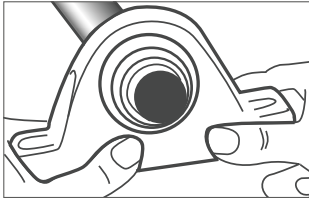

1. Relieve set screws clear of the bore and slide bearing onto the shaft.

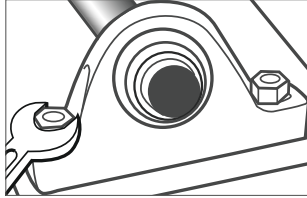

2. Bolt the unit down on to a flat surface but do not over-tighten.

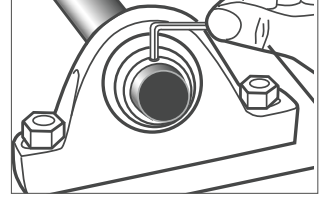

3. Tighten set screws to recommended torque

Self-Lube® eccentric collar locking arrangements units

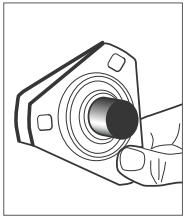

1. Assemble bearing and housing and slide onto the shaft. Do not engage collar.

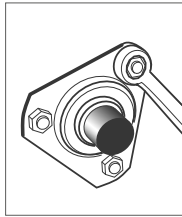

2. Lightly tighten bolts, repeat at other end of shaft and then finally tighten bolts on both sides.

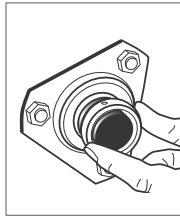

3. Engage the eccentric collar in direction of shaft rotation.

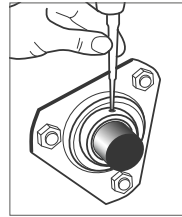

4. Tighten collar with drift pin and small hammer.

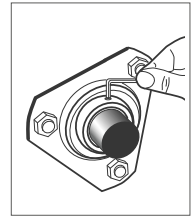

5. Tighten collar set screw to recommended torque.

Maximum recommended steady housing loads

The maximum loads shown adjacent are given as a proportion of the static load rating (C_{0r}) of the bearing insert. Where the value of the axial load exceeds the set screw maximum axial holding load listed on page 16, a shoulder on the shaft must be provided against the face of the inner ring.

For shock load conditions additional safety factors must be applied.

Housing strength limits

Radial Loads Axial loads

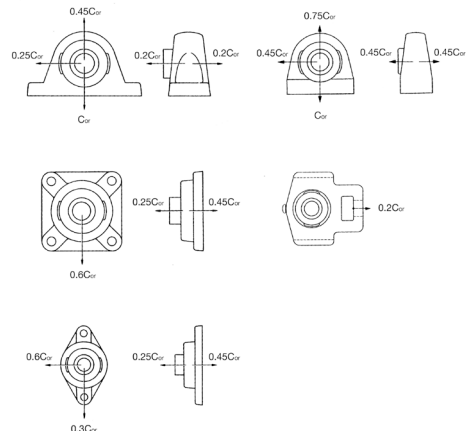

Tolerances and speeds

Inner ring bore tolerances - Set screw and eccentric collar types

Nominal bore diameter d				Tolerances			
mm above	incl.	inch above	incl.	0.001mm units		0.0001 inch units	
				high	low	high	low
10	18	0.3937	0.7087	+15	0	+6	0
18	31.750	0.7087	1.2500	+18	0	+7	0
31.750	50.800	1.2500	2.0000	+21	0	+8	0
50.800	80	2.0000	3.1496	+24	0	+9	0
80	100	3.1496	3.9370	+28	0	+11	0

Outer ring outside diameter tolerances

Nominal outside diameter d		Outside Diameter Tolerances				Width Tolerances					
mm above	incl.	0.001mm units		0.0001 inch units		Nominal bearing bore		0.001mm units		0.0001 inch units	
		high	low	high	low	mm above	including	high	low	high	low
30	50	0	-11	0	-4	9	18	0	-120	0	-47
50	80	0	-13	0	-5	18	30	0	-120	0	-47
80	120	0	-15	0	-6	30	50	0	-120	0	-47
120	150	0	-18	0	-7	50	80	0	-150	0	-59
150	180	0	-25	0	-10	80	120	0	-200	0	-78
180	250	0	-30	0	-12	-	-	-	-	-	-

Housing tolerances for parallel outside diameter inserts - series 1100, 1100DEC, 1300 and 1300EC

Nominal housing bore	Stationary outer ring Housing tolerance ISO H7				Rotating outer ring Housing tolerance ISO N7			
	0.001mm units		0.0001 inch units		0.001mm units		0.0001 inch units	
	high	low	high	low	high	low	high	low
40	+25	0	+10	0	-8	-33	-3	-13
47	+25	0	+10	0	-8	-33	-3	-13
52	+30	0	+12	0	-9	-39	-4	-15
62	+30	0	+12	0	-9	-39	-4	-15
72	+30	0	+12	0	-9	-39	-4	-15
80	+30	0	+12	0	-9	-39	-4	-15
85	+35	0	+14	0	-10	-45	-4	-18
90	+35	0	+14	0	-10	-45	-4	-18
100	+35	0	+14	0	-10	-45	-4	-18
110	+35	0	+14	0	-10	-45	-4	-18
120	+35	0	+14	0	-10	-45	-4	-18
125	+40	0	+16	0	-12	-52	-5	-20
130	+40	0	+16	0	-12	-52	-5	-20
140	+40	0	+16	0	-12	-52	-5	-20
150	+40	0	+16	0	-12	-52	-5	-20
160	+40	0	+16	0	-12	-52	-5	-20

Shaft tolerances and permissible speeds

Basic bearing insert	Shaft dia.		Max speed rev/min	High loads - high speeds				Max speed rev/min	Normal applications				Max speed rev/min	Light loads - low speeds			
	mm	inches		Shaft tolerance ISO h6					Shaft tolerance ISO h7					Shaft tolerance ISO h9			
				0.001mm units		0.0001 inch units			0.001mm units		0.0001 inch units			0.001mm units		0.0001 inch units	
				high	low	high	low		high	low	high	low		high	low	high	low
1017	12-17	½-1¼	7000	0	-11	0	-4	5000	0	-18	0	-7	2000	0	-43	0	-17
1020	20	¾	6700	0	-13	0	-5	4200	0	-21	0	-8	1700	0	-52	0	-20
1025	25	1⅜-1	6250	0	-13	0	-5	3600	0	-21	0	-8	1350	0	-52	0	-20
1030	25-30	⅞-1¼	5300	0	-13	0	-5	3100	0	-21	0	-8	1100	0	-52	0	-20
1035	30-35	1½-1⅞	4500	0	-16	0	-6	2700	0	-25	0	-10	900	0	-62	0	-24
1040	35-40	1⅜-19/16	4000	0	-16	0	-6	2400	0	-25	0	-10	750	0	-62	0	-24
1045	40-45	1½-1¾	3700	0	-16	0	-6	2200	0	-25	0	-10	600	0	-62	0	-24
1050	45-50	1½-2	3400	0	-16	0	-6	1950	0	-25	0	-10	500	0	-62	0	-24
1055	50-55	1⅞-2⅜	3100	0	-19	0	-7	1800	0	-30	0	-12	450	0	-74	0	-29
1060	55-60	2½-2⅞	2800	0	-19	0	-7	1600	0	-30	0	-12	400	0	-74	0	-29
1065	65	2½	2600	0	-19	0	-7	1500	0	-30	0	-12	350	0	-74	0	-29
1070	60-70	1⅞-2¼	2450	0	-19	0	-7	1400	0	-30	0	-12	300	0	-74	0	-29
1075	65-75	2¼-2⅞	2300	0	-19	0	-7	1300	0	-30	0	-12	280	0	-74	0	-29
1080	75-80	2⅞-3¼	2150	0	-19	0	-7	1200	0	-30	0	-12	250	0	-74	0	-29
1085	80-85	3¼-3⅞	2000	0	-22	0	-9	1100	0	-35	0	-14	220	0	-87	0	-34
1090	85-90	3⅞-3½	1900	0	-22	0	-9	1050	0	-35	0	-14	200	0	-87	0	-34
3095	95-100	3 ⅞-4	1600	0	-22	0	-9	1000	0	-35	0	-14	180	0	-87	0	-34

For most applications the standard set screw lock is more than satisfactory. Whenever eccentric collar units are used it is recommended that shaft tolerances in the high loads column be adopted. Whenever taper adapter sleeve locking arrangements are used, shaft tolerances in the light loads column can be adopted. When operating conditions are very severe (for example, in case of heavy vibration or shock) a light interference fit may be required between the shaft and bearing bore diameter.

Housing tolerances for bearing units - series FC, MFC, SLC and MSC

Bearing unit reference	Housing tolerance	
	Stationary housing	Rotating housing
SLC MSC	ISO H7	ISO N7
FC MFC	ISO H7	ISO H7

Radial Internal Clearance (RIC)

Radial Internal Clearance	Bearing Type
C3	Standard Self-Lube® bearing series
C4	Taper Sleeve Locking bearing series
C5	HLT bearing series



Self-Lube® Bearing Tables

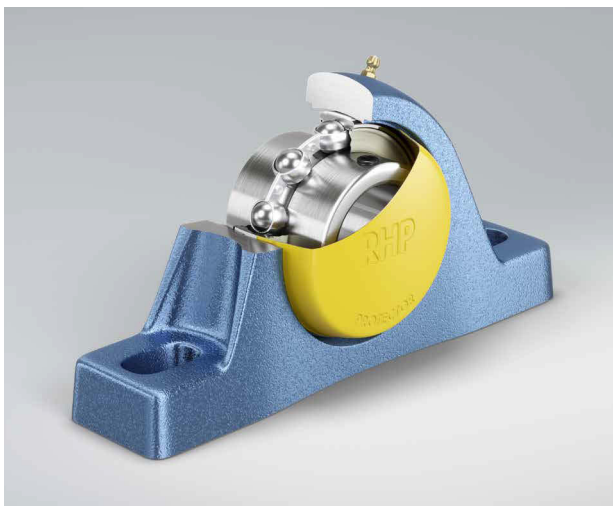

Self-Lube® cast iron pillow block units

NP Series

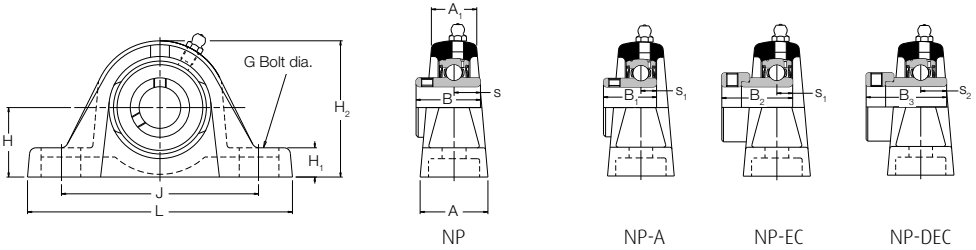

Shaft diameter mm inches	RHP designation				Basic bearing insert	Casting group	Dimensions (mm)				Bolt centres	
	L	H	H ₁	H ₂			J _{max}	J _{min}				
12	NP12A		NP12EC		1017	1	126.5	30.20	14.2	57.2	100.5	85.5
15	NP15A		NP15EC									
16	NP16		NP16EC									
17	NP17A		NP17EC									
1/2	NP1/2		NP1/2EC									
3/8	NP3/8A		NP3/8EC									
20	NP20	NP20A	NP20EC	NP20DEC	1020	2	127.0	33.30	14.0	65.2	100.5	88.5
3/4	NP3/4	NP3/4A	NP3/4EC	NP3/4DEC								
25	NP25	NP25A	NP25EC	NP25DEC	1025	3	139.0	36.50	16.0	71.0	112.7	96.8
7/8	NP7/8		NP7/8EC	NP7/8DEC								
15/16	NP15/16		NP15/16EC	NP15/16DEC								
1	NP1	NP1A	NP1EC	NP1DEC								
30	NP30	NP30A	NP30EC	NP30DEC	1030	4	160.5	42.90	17.7	82.7	129.5	108.5
1 1/8	NP1 1/8		NP1 1/8EC	NP1 1/8DEC								
1 3/16	NP1 3/16		NP1 3/16EC	NP1 3/16DEC								
1 1/4	NP1 1/4R	NP1 1/4AR	NP1 1/4ECR	NP1 1/4DEC R								
35	NP35	NP35A	NP35EC	NP35DEC	1035	5	166.0	47.60	17.5	93.0	136.5	121.5
1 1/4	NP1 1/4	NP1 1/4A	NP1 1/4EC	NP1 1/4DEC								
1 3/8	NP1 3/8		NP1 3/8EC	NP1 3/8DEC								
1 7/16	NP1 7/16		NP1 7/16EC	NP1 7/16DEC								
40	NP40	NP40A	NP40EC	NP40DEC	1040	6	180.5	49.20	18.5	98.5	148.0	127.0
1 1/2	NP1 1/2	NP1 1/2A	NP1 1/2EC	NP1 1/2DEC								
45	NP45	NP45A	NP45EC	NP45DEC	1045	7	190.5	54.00	20.0	108.0	154.5	140.5
1 5/8	NP1 5/8		NP1 5/8EC	NP1 5/8DEC								
1 11/16	NP1 11/16		NP1 11/16EC	NP1 11/16DEC								
1 3/4	NP1 3/4	NP1 3/4A	NP1 3/4EC	NP1 3/4DEC								
50	NP50	NP50A	NP50EC	NP50DEC	1050	8	206.0	57.20	21.0	115.2	163.0	154.0
1 7/8	NP1 7/8		NP1 7/8EC	NP1 7/8DEC								
1 15/16	NP1 15/16		NP1 15/16EC	NP1 15/16DEC								
2	NP2R			NP2DEC R								
55	NP55			NP55DEC	1055	9	219.5	63.50	24.8	129.5	178.5	162.5
2	NP2			NP2DEC								
2 1/8	NP2 1/8			NP2 1/8DEC								
2 3/16	NP2 3/16			NP2 3/16DEC								
60	NP60			NP60DEC	1060	10	240.0	69.90	26.3	142.3	201.0	176.0
2 1/4	NP2 1/4			NP2 1/4DEC								
2 3/8	NP2 3/8			NP2 3/8DEC								
2 1/2	NP2 1/2			NP2 1/2DEC								

Please check availability

Bearing inserts with flinger seals shown on pages 89 and 90 can be fitted into these housings. The unit reference has the suffix 'FS', e.g. NP40FS.

Triple seal bearing inserts shown on pages 86 to 88 can be fitted into these housings. The unit reference has a prefix 'T', e.g. TNP25.

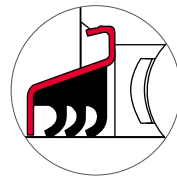
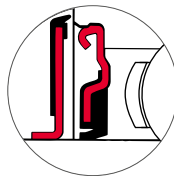

G	Dimensions (mm)									ISO Load ratings		Rec. max. speed rev/min	Mass (approx.) kg
	A	A ₁	B	B ₁	B ₂	B ₃	s	s ₁	s ₂	dynamic C _r newtons	static C _{0r} newtons		
10	30.5	20.5	27.38	-	28.63	-	11.58	6.53	-	9550	4800	7000	0.5
10	32.5	22.5	31.00	25.80	31.03	43.73	12.73	7.53	17.13	12800	6650	6700	0.6
10	36.5	24.5	34.10	27.30	31.03	44.43	14.33	7.53	17.53	14000	7880	6250	0.7
12	41.5	27.5	38.10	31.20	35.73	48.43	15.93	9.03	18.33	19500	11300	5300	1.3
12	44.5	30.5	42.90	34.90	38.93	51.13	17.53	9.53	18.83	25700	15300	4500	1.7
12	51.0	34.5	49.20	41.20	43.73	56.33	19.03	11.03	21.43	32500	19900	4000	2.1
12	54.0	36.0	49.20	41.20	43.73	56.33	19.04	11.04	21.44	32500	20500	3700	2.8
16	55.0	36.0	51.60	43.50	43.73	62.73	19.04	11.04	24.64	35000	23200	3400	3.2
16	60.0	39.5	55.60	-	-	71.42	22.24	-	27.84	43500	29200	3100	4.0
16	70.0	46.0	65.10	-	-	77.84	25.44	-	31.04	48000	33000	2800	5.9

Self-Lube® cast iron pillow block units

NP Series (continued)

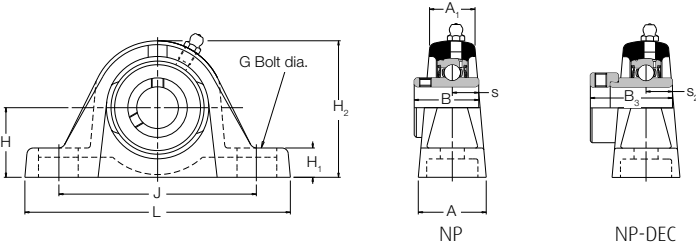

Shaft diameter		RHP designation		Basic bearing insert	Casting group	Dimensions (mm)				Bolt centres	
mm	inches					L	H	H ₁	H ₂	J _{max}	J _{min}
65		NP65	NP65DEC	1065	10/65	250.0	69.90	26.3	144.3	205.0	176.0
	2½	NP2½	NP2½DEC								
70		NP70	NP70DEC	1070	11	266.0	79.40	30.2	156.0	220.0	200.0
	2⅞	NP2⅞									
75		NP75	NP75DEC	1075	12	275.0	82.60	28.0	164.0	228.0	206.0
	2¾	NP2¾									
	2⅞	NP2⅞									
	2⅞	NP2⅞									
80		NP80		1080	13	291.0	88.90	30.0	174.0	241.0	214.0
	3	NP3									
	3	NP3L									
85		NP85		1085	14	310.0	95.20	32.0	187.0	262.0	232.0
	3¼	NP3¼									
	3⅝	NP3⅝									
90		NP90		1090	15	327.0	101.60	36.0	200.0	280.0	244.0
	3⅞	NP3⅞									
	3⅞	NP3⅞									

Please check availability

G	Dimensions (mm)									ISO Load ratings		Rec. max. speed rev/min	Mass (approx.) kg
	A	A ₁	B	B ₁	B ₂	B ₃	s	s ₁	s ₂	dynamic C _r newtons	static C _{0r} newtons		
16	70.0	45.0	65.10	-	-	85.74	25.44	-	34.14	57500	40000	2600	5.9
24	72.0	47.0	74.60	-	-	85.74	30.24	-	34.14	61000	45000	2450	8.0
24	74.0	48.0	77.80	-	-	92.14	33.34	-	37.34	66000	49500	2300	9.0
24	78.0	56.0	82.60	-	-	-	33.34	-	-	71500	54500	2150	9.7
24	83.0	56.0	85.70	-	-	-	34.15	-	-	83000	64000	2000	11.8
24	88.0	62.0	96.00	-	-	-	39.74	-	-	96000	71500	1900	14.7

Self-Lube® cast iron pillow block units with adapter sleeves

NP1000-K Series

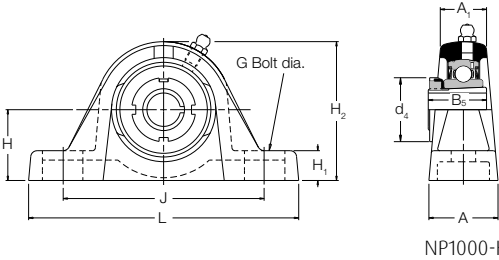

NP1000-K

Shaft diameter		RHP designation complete unit	Sleeve nut & lockwasher only	Unit without sleeve, nut & lockwasher	Basic bearing insert	Casting group	Dimensions (mm)				Bolt centres	
mm	inches						L	H	H ₁	H ₂	J _{max}	J _{min}
20		NP1025-20K	H305	NP1025K	1025	3	139 ^a	36.50	16.0	71.0	112.7	96.8
	¾	NP1025-¾K	HE305-¾									
25		NP1030-25K	H306	NP1030K	1030	4	160.5	42.90	17.7	82.7	129.5	108.5
	15/16	NP1030-15/16K	HE306-15/16									
30	1	NP1030-1K	HE306-1									
		NP1035-30K	H307	NP1035K	1035	5	166.0	47.60	17.5	93.0	136.5	121.5
35	1 1/8	NP1035-1 1/8K	HE307-1 1/8									
	1 3/16	NP1035-1 3/16K	HE307-1 3/16									
40		NP1040-35K	H308	NP1040K	1040	6	180.5	49.20	18.5	98.5	148.0	127.0
	1 1/4	NP1040-1 1/4K	HE308-1 1/4									
45	1 3/8	NP1040-1 3/8K	HE308-1 3/8									
		NP1045-40K	H309	NP1045K	1045	7	190.5	54.00	20.0	108.0	154.5	140.5
50	1 7/16	NP1045-1 7/16K	HE309-1 7/16									
	1 1/2	NP1045-1 1/2K	HE309-1 1/2									
55		NP1050-45K	H310	NP1050K	1050	8	206.0	57.20	21.0	115.2	163.0	154.0
	1 1/16	NP1050-1 1/16K	HE310-1 1/16									
60	1 3/4	NP1050-1 3/4K	HE310-1 3/4									
		NP1055-50K	H311	NP1055K	1055	9	219.5	63.50	24.8	129.5	178.5	162.5
65	1 5/16	NP1055-1 5/16K	HE311-1 5/16									
	2	NP1055-2K	HE311-2									

Please check availability

Dimensions (mm)					ISO Load ratings		Rec. max. speed rev/min	Mass (approx.) kg
G	A	A ₁	B ₅	d ₄	dynamic C _r newtons	static C _{0r} newtons		
10	36.5	24.5	29.0	38.0	14000	7880	6250	0.7
12	41.5	27.5	31.0	45.0	19500	11300	5300	1.3
12	44.5	30.5	35.0	52.0	25700	15300	4500	1.7
12	51.0	34.5	36.0	58.0	32500	19900	4000	2.1
12	54.0	35.0	39.0	65.0	32500	20500	3700	2.8
16	55.0	36.0	42.0	70.0	35000	23200	3400	3.2
16	60.0	39.5	45.0	75.0	43500	29200	3100	4.0

Self-Lube® cast iron pillow block units

SL Series

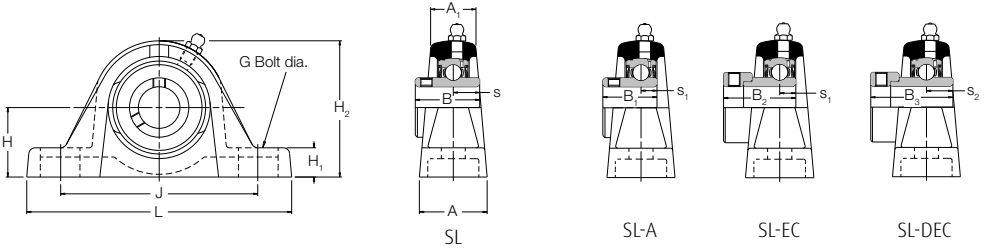

Shaft diameter		RHP designation				Basic bearing insert	Casting group	Dimensions (mm)				Bolt centres	
mm	inches							L	H	H ₁	H ₂	J _{max}	J _{min}
12		SL12		SL12EC		1017	1	119.0	26.97	11.0	54.0	91.5	85.5
15		SL15		SL15EC									
16		SL16		SL16EC									
17		SL17		SL17EC									
	1/2	SL1 1/2		SL1 1/2 EC									
	5/8	SL1 5/8		SL1 5/8 EC									
20		SL20	SL20A	SL20EC	SL20DEC	1020	2	126.5	31.75	12.5	63.7	100.5	88.5
	3/4	SL3/4	SL3/4A	SL3/4EC	SL3/4DEC								
25		SL25	SL25A	SL25EC	SL25DEC	1025	3	139.0	33.32	12.8	67.8	110.2	98.2
	7/8	SL7/8		SL7/8EC	SL7/8DEC								
	15/16	SL1 5/16		SL1 5/16 EC	SL1 5/16 DEC								
30		SL1	SL1A	SL1EC	SL1DEC								
	1 1/8	SL1 1/8		SL1 1/8 EC	SL1 1/8 DEC	1030	4	161.5	39.67	14.5	79.5	130.0	109.0
	1 3/16	SL1 3/16		SL1 3/16 EC	SL1 3/16 DEC								
	1 1/4	SL1 1/4 R	SL1 1/4 AR	SL1 1/4 ECR	SL1 1/4 DEC R								
35		SL35	SL35A	SL35EC	SL35DEC	1035	5	166.0	46.02	16.0	91.5	136.5	121.5
	1 1/4	SL1 1/4	SL1 1/4 A	SL1 1/4 EC	SL1 1/4 DEC								
	1 3/8	SL1 3/8		SL1 3/8 EC	SL1 3/8 DEC								
	1 7/16	SL1 7/16		SL1 7/16 EC	SL1 7/16 DEC								
40		SL40	SL40A	SL40EC	SL40DEC	1040	6	180.5	49.20	18.5	98.5	148.0	127.0
	1 1/2	SL1 1/2	SL1 1/2 A	SL1 1/2 EC	SL1 1/2 DEC								
45		SL45	SL45A	SL45EC	SL45DEC	1045	7	197.5	52.37	18.4	106.4	161.5	141.5
	1 5/8	SL1 5/8		SL1 5/8 EC	SL1 5/8 DEC								
	1 11/16	SL1 11/16		SL1 11/16 EC	SL1 11/16 DEC								
	1 3/4	SL1 3/4	SL1 3/4 A	SL1 3/4 EC	SL1 3/4 DEC								
50		SL50	SL50A	SL50EC	SL50DEC	1050	8	214.0	55.55	19.3	114.0	177.0	151.0
	1 7/8	SL1 7/8		SL1 7/8 EC	SL1 7/8 DEC								
	1 15/16	SL1 15/16		SL1 15/16 EC	SL1 15/16 DEC								
	2	SL2R			SL2DEC R								
55		SL55		SL55EC	SL55DEC	1055	9	219.5	61.90	23.2	128.0	178.5	162.5
	2	SL2		SL2EC	SL2DEC								
	2 1/8	SL2 1/8		SL2 1/8 EC	SL2 1/8 DEC								
	2 3/16	SL2 3/16		SL2 3/16 EC	SL2 3/16 DEC								
60		SL60		SL60EC	SL60DEC	1060	10	240.0	68.25	24.6	140.6	201.0	176.0
	2 1/4	SL2 1/4		SL2 1/4 EC	SL2 1/4 DEC								
	2 3/8	SL2 3/8		SL2 3/8 EC	SL2 3/8 DEC								
	2 7/16	SL2 7/16		SL2 7/16 EC	SL2 7/16 DEC								
65		SL65R				1065	10/65	250.0	68.25	24.6	142.6	205.0	176.0
	2 1/2	SL2 1/2		SL2 1/2 EC	SL2 1/2 DEC								
65		SL65		SL65EC	SL65DEC	1075	11	286.0	82.55	28.0	165.5	241.5	200.5
70		SL70		SL70EC	SL70DEC								
75		SL75		SL75EC	SL75DEC								
	2 11/16	SL2 11/16		SL2 11/16 EC	SL2 11/16 DEC								
	2 3/4	SL2 3/4		SL2 3/4 EC	SL2 3/4 DEC								
	2 7/8	SL2 7/8		SL2 7/8 EC	SL2 7/8 DEC								
	2 15/16	SL2 15/16		SL2 15/16 EC	SL2 15/16 DEC								

Please check availability

Bearing inserts with flinger seals shown on pages 89 and 90 can be fitted into these housings. The unit reference has the suffix 'FS', e.g. SL35FS.

Triple seal bearing inserts shown on pages 86 to 88 can be fitted into these housings. The unit reference has a prefix 'T', e.g. TSL35.

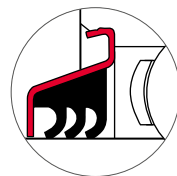
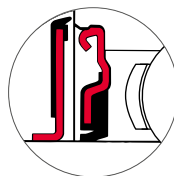

Dimensions (mm)										ISO Load ratings		Rec. max. speed	Mass (approx.)
G	A	A ₁	B	B ₁	B ₂	B ₃	s	s ₁	s ₂	dynamic C _r newtons	static C _{0r} newtons	rev/min	kg
10	30.5	20.5	27.38	-	28.63	-	11.58	6.53	-	9550	4800	7000	0.5
10	32.0	22.5	31.00	25.80	31.03	43.73	12.73	7.53	17.13	12800	6650	6700	0.6
10	36.0	24.5	34.10	27.30	31.03	44.43	14.33	7.53	17.53	14000	7880	6250	0.7
12	41.0	27.5	38.10	31.20	35.73	48.43	15.93	9.03	18.33	19500	11300	5300	1.3
12	44.5	30.5	42.90	34.90	38.93	51.13	17.53	9.53	18.83	25700	15300	4500	1.7
12	51.0	34.5	49.20	41.20	43.73	56.33	19.03	11.03	21.43	32500	19900	4000	2.1
12	54.0	35.0	49.20	41.20	43.73	56.33	19.04	11.04	21.43	32500	20500	3700	3.0
12	55.0	36.0	51.60	43.50	43.73	62.73	19.04	11.04	24.64	35000	23200	3400	3.4
16	60.0	39.5	55.60	-	-	71.42	22.24	-	27.84	43500	29200	3100	4.0
16	70.0	46.0	65.10	-	-	77.84	25.44	-	31.04	48000	33000	2800	6.1
16	70.0	45.0	65.10	-	-	85.74	25.44	-	34.14	57500	40000	2600	6.2
20	74.0	47.5	77.80	-	-	92.14	33.34	-	37.34	66000	49500	2300	11.6

Self-Lube® cast iron pillow block units

MP Series

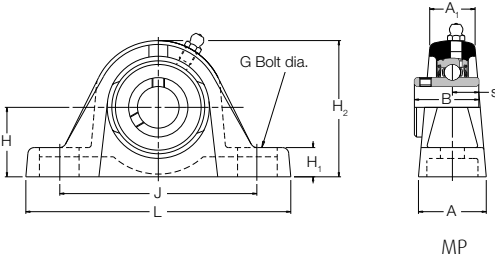

MP

Shaft diameter		RHP designation	Basic bearing insert	Casting group	Dimensions (mm)				Bolt centres	
mm	inches				L	H	H ₁	H ₂	J _{max}	J _{min}
25		MP25	1030	1	160.5	44.45	19.0	84.3	127.5	108.5
	1	MP1								
30		MP30	1035	2	166.0	47.60	17.5	93.0	136.5	121.5
	1 ³ / ₁₆	MP1 ³ / ₁₆								
	1 ¹ / ₄	MP1 ¹ / ₄								
35		MP35	1040	3	203.2	53.98	23.0	107.5	160.0	135.0
	1 ³ / ₈	MP1 ³ / ₈								
	1 ⁷ / ₁₆	MP1 ⁷ / ₁₆								
40		MP40	1045	4	222.2	58.72	22.5	116.7	172.5	145.0
	1 ¹ / ₂	MP1 ¹ / ₂								
45		MP45	1050	5	222.2	58.72	22.5	116.7	172.5	145.0
	1 ¹¹ / ₁₆	MP1 ¹¹ / ₁₆								
	1 ³ / ₄	MP1 ³ / ₄								
50		MP50	1055	6	219.5	63.50	24.8	129.5	178.5	162.5
	1 ⁷ / ₈	MP1 ⁷ / ₈								
	1 ¹⁵ / ₁₆	MP1 ¹⁵ / ₁₆								
	2	MP2								
55		MP55	1060	7	249.5	69.85	26.2	142.2	201.0	179.0
	2 ³ / ₁₆	MP2 ³ / ₁₆								
	2 ¹ / ₄	MP2 ¹ / ₄								
60		MP60	1070	8	266.0	76.20	27.0	153.0	224.5	189.5
65		MP65R								
	2 ⁷ / ₁₆	MP2 ⁷ / ₁₆								
	2 ¹ / ₂	MP2 ¹ / ₂								
65		MP65	1075	9	330.2	88.90	28.6	177.8	255.6	206.0
70		MP70								
	2 ¹¹ / ₁₆	MP2 ¹¹ / ₁₆								
	2 ³ / ₄	MP2 ³ / ₄								
75		MP75	1080	10	330.2	88.90	31.8	184.2	255.6	228.0
	2 ¹⁵ / ₁₆	MP2 ¹⁵ / ₁₆								
	3	MP3								
80		MP80	1085	11	381.0	101.60	31.8	203.2	317.5	260.0
	3 ¹ / ₁₆	MP3 ¹ / ₁₆								
	3 ¹ / ₄	MP3 ¹ / ₄								
85		MP85	1090	12	381.0	101.60	33.3	209.6	319.1	246.1
90		MP90								
	3 ⁷ / ₁₆	MP3 ⁷ / ₁₆								
	3 ¹ / ₂	MP3 ¹ / ₂								
95		MP95								
100		MP100	3095	13	431.8	127.00	33.3	254.0	371.5	301.6
	3 ¹⁵ / ₁₆	MP3 ¹⁵ / ₁₆								
	4	MP4								

Please check availability

Bearing inserts with flinger seals shown on pages 89 and 90 can be fitted into these housings. The unit reference has the suffix 'FS', e.g. MP40FS.

Triple seal bearing inserts shown on pages 86 to 88 can be fitted into these housings. The unit reference has a prefix 'T', e.g. TMP40.

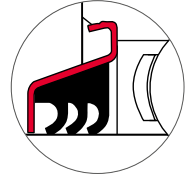
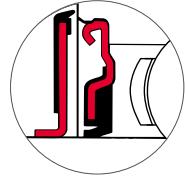

Dimensions (mm)					ISO Load ratings		Rec. max. speed	Mass (approx.)
G	A	A ₁	B	s	dynamic C _r newtons	static C _{0r} newtons	rev/min	kg
12	41.5	27.5	38.10	15.93	19500	11300	5300	1.3
12	44.5	30.5	42.90	17.53	25700	15300	4500	1.7
12	57.0	40.5	49.20	19.03	32500	19900	4000	2.7
16	60.0	39.5	49.20	19.04	32500	20500	3700	3.2
16	60.0	39.5	51.60	19.04	35000	23200	3400	3.2
16	60.0	39.5	55.60	22.24	43500	29200	3100	4.0
20	69.5	46.00	65.10	25.44	48000	33000	2800	7.1
20	72.0	47.0	74.60	30.24	61000	45000	2450	9.3
24	88.9	66.7	77.80	33.34	66000	49500	2300	13.4
24	88.9	66.7	82.60	33.34	71500	54500	2150	14.3
24	101.6	68.3	85.70	34.15	83000	64000	2000	18.2
24	111.1	79.4	96.00	39.74	96000	71500	1900	23.4
24	120.6	98.4	117.48	49.31	157000	122000	1600	34.4

Self-Lube® cast iron pillow block units with adapter sleeves

MP1000-K Series

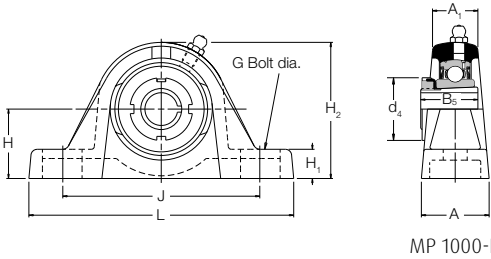

Shaft diameter		RHP designation complete unit	Sleeve nut & lockwasher only	Unit without sleeve, nut & lockwasher	Basic bearing insert	Casting group	Dimensions (mm)				Bolt centres	
							L	H	H ₁	H ₂	J _{max}	J _{min}
mm	inches											
25		MP1030-25K	H306	MP1030K	1030	1	160.5	44.45	19.3	87.4	127.5	108.5
	¹⁵ / ₁₆	MP1030- ¹⁵ / ₁₆ K	HE306- ¹⁵ / ₁₆									
	1	MP1030-1K	HE306-1									
30		MP1035-30K	H307	MP1035K	1035	2	166.0	47.60	17.5	93.0	136.5	121.5
	¹ / ₈	MP1035- ¹ / ₈ K	HE307- ¹ / ₈									
	¹³ / ₁₆	MP1035- ¹³ / ₁₆ K	HE307- ¹³ / ₁₆									
35		MP1040-35K	H308	MP1040K	1040	3	203.2	53.98	23.0	106.4	160.0	135.0
	¹ / ₄	MP1040- ¹ / ₄ K	HE308- ¹ / ₄									
	¹³ / ₈	MP1040- ¹³ / ₈ K	HE308- ¹³ / ₈									
40		MP1045-40K	H309	MP1045K	1045	4	222.2	58.72	22.5	116.7	172.5	145.0
	¹⁷ / ₁₆	MP1045- ¹⁷ / ₁₆ K	HE309- ¹⁷ / ₁₆									
	¹ / ₂	MP1045- ¹ / ₂ K	HE309- ¹ / ₂									
45		MP1050-45K	H310	MP1050K	1050	5	222.2	58.72	22.5	116.7	172.5	145.0
	¹¹ / ₁₆	MP1050- ¹¹ / ₁₆ K	HE310- ¹¹ / ₁₆									
	³ / ₄	MP1050- ³ / ₄ K	HE310-2									
50		MP1055-50K	H311	MP1055K	1055	6	219.5	63.50	24.8	129.5	178.5	162.5
	¹⁵ / ₁₆	MP1055- ¹⁵ / ₁₆ K	HE311- ¹⁵ / ₁₆									
	2	MP1055-2K	HE311-2									

Please check availability

Dimensions (mm)					ISO Load ratings		Rec. max. speed rev/min	Mass (approx.) kg
G	A	A ₁	B ₅	d ₄	dynamic C _r newtons	static C _{0r} newtons		
12	41.5	27.5	31.00	45.00	19500	11300	5300	1.3
12	44.5	30.5	35.00	52.00	25700	15300	4500	1.7
12	57.0	40.5	36.00	58.00	32500	19900	4000	2.7
16	60.0	39.5	39.00	65.00	32500	20500	3700	3.2
16	60.0	39.5	42.00	70.00	35000	23200	3400	3.2
16	60.0	39.5	45.00	75.00	43500	29200	3100	4.0

Self-Lube® short base cast iron pillow block units

SNP Series (metric thread), CNP Series (UNC thread)**

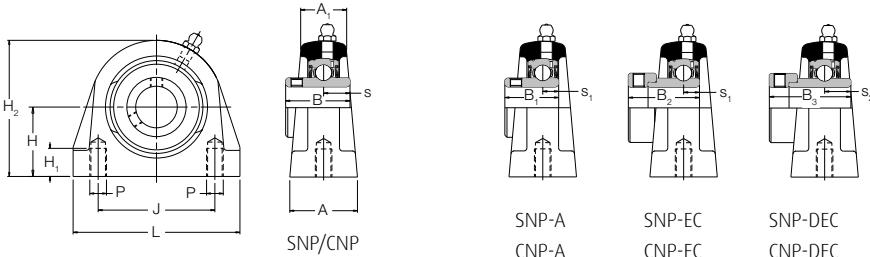

Shaft diameter		RHP designation				Basic bearing insert	Casting group	Dimensions (mm)				Bolt centres	
mm	inches							L	H	H ₁	H ₂	J	SNP
20		SNP20	SNP20A	SNP20EC	SNP20DEC	1020	2	65.0	33.30	13.5	65.8	50.8	M8x1.25
		SNP3/4	SNP3/4A	SNP3/4EC	SNP3/4DEC								
25		SNP25	SNP25A	SNP25EC	SNP25DEC	1025	3	70.0	36.50	13.5	71.5	50.8	M10x1.50
		SNP7/8		SNP7/8EC	SNP7/8DEC								
		SNP15/16		SNP15/16EC	SNP15/16DEC								
30		SNP1	SNP1A	SNP1EC	SNP1DEC	1030	4	96.0	42.90	16.5	83.9	76.2	M10x1.50
		SNP30	SNP30A	SNP30EC	SNP30DEC								
		SNP17/8		SNP17/8EC	SNP17/8DEC								
		SNP13/16		SNP13/16EC	SNP13/16DEC								
35		SNP17/4R	SNP17/4AR	SNP17/4ECR	SNP17/4DECR	1035	5	110.0	47.60	19.5	95.6	82.6	M10x1.50
		SNP35	SNP35A	SNP35EC	SNP35DEC								
		SNP13/8		SNP13/8EC	SNP13/8DEC								
		SNP17/16		SNP17/16EC	SNP17/16DEC								
40		SNP40	SNP40A	SNP40EC	SNP40DEC	1040	6	118.0	49.20	19.5	101.7	88.9	M12x1.75
		SNP11/2	SNP11/2A	SNP11/2EC	SNP11/2DEC								
45		SNP45	SNP45A	SNP45EC	SNP45DEC	1045	7	127.0	54.00	19.5	110.0	95.3	M12x1.75
		SNP15/8		SNP15/8EC	SNP15/8DEC								
		SNP111/16		SNP111/16EC	SNP111/16DEC								
		SNP13/4	SNP13/4A	SNP13/4EC	SNP13/4DEC								
50		SNP50	SNP50A	SNP50EC	SNP50DEC	1050	8	135.0	57.20	23.5	115.0	101.6	M16x2.00
		SNP17/8		SNP17/8EC	SNP17/8DEC								
		SNP115/16		SNP115/16EC	SNP115/16DEC								
55		SNP2R				1055	9	150.0	63.50	26.5	130.0	118.0	M16x2.00
		SNP55		SNP55DEC									
		SNP2		SNP2DEC									
		SNP21/8		SNP21/8DEC									
60		SNP23/16		SNP23/16DEC		1060	10	154.0	69.90	26.5	141.5	118.0	M16x2.00
		SNP60		SNP60DEC									
		SNP23/8		SNP23/8DEC									
		SNP27/16		SNP27/16DEC									
		SNP21/4		SNP21/4DEC									

Please check availability

**These units are identical to SNP series except for thread details

Bearing inserts with flinger seals shown on pages 89 and 90 can be fitted into these housings. The unit reference has the suffix 'FS', e.g. SNP25FS.

Triple seal bearing inserts shown on pages 86 to 88 can be fitted into these housings. The unit reference has a prefix 'T', e.g. TSNP25.

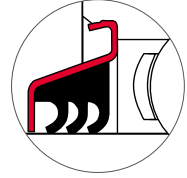
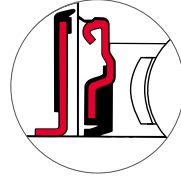

P	Dimensions (mm)										ISO Load ratings		Rec. max. speed rev/min	Mass (approx.) kg
	CNP	A	A ₁	B	B ₁	B ₂	B ₃	s	s ₁	s ₂	dynamic C _r newtons	static C _{0r} newtons		
3/8-16UNC	32.0	21.5	31.00	25.80	31.03	43.73	12.73	7.53	17.13		12800	6650	6700	0.9
3/8-16UNC	36.0	25.0	34.10	27.30	31.03	44.43	14.33	7.53	17.53		14000	7880	6250	1.2
7/16-14UNC	40.0	26.5	38.10	31.20	35.73	48.43	15.93	9.03	18.33		19500	11300	5300	1.8
1/2-13UNC	45.0	30.0	42.90	34.90	38.93	51.13	17.53	9.53	18.83		25700	15300	4500	2.4
1/2-13UNC	47.0	32.0	49.20	41.20	43.73	56.33	19.03	11.03	21.43		32500	19900	4000	2.0
1/2-13UNC	48.0	33.0	49.20	41.20	43.73	56.33	19.04	11.04	21.43		32500	20500	3700	2.4
5/8-11UNC	54.0	35.5	51.60	43.50	43.73	62.73	19.04	11.04	24.64		35000	23200	3400	3.3
5/8-11UNC	60.0	41.5	55.60	-	-	71.42	22.24	-	27.84		43500	29200	3100	4.0
5/8-11UNC	60.0	41.5	65.10	-	-	77.84	25.44	-	31.04		48000	33000	2800	4.6

Self-Lube® cast iron flange bearing units SF Series

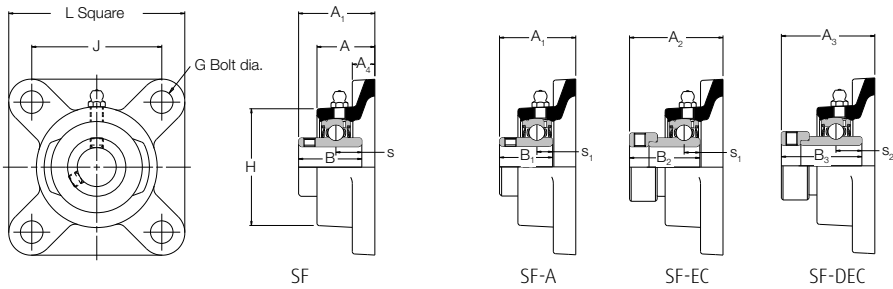

Shaft diameter		RHP designation				Basic bearing insert	Casting group	Dimensions (mm)					
mm	inches							L	H	J	G	A	A ₁
12		SF12		SF12EC		1017	1	76.2	52.5	54.00	10	24.6	32.87
15		SF15		SF15EC									
16		SF16		SF16EC									
17		SF17		SF17EC									
1/2		SF1/2		SF1/2EC									
3/8		SF3/8		SF3/8EC									
20		SF20	SF20A	SF20EC	SF20DEC	1020	2	85.7	60.3	63.50	10	27.8	37.26
	3/4	SF3/4	SF3/4A	SF3/4EC	SF3/4DEC								
25		SF25	SF25A	SF25EC	SF25DEC	1025	3	95.3	68.0	70.00	10	28.6	38.84
7/8		SF7/8		SF7/8EC	SF7/8DEC								
15/16		SF15/16		SF15/16EC	SF15/16DEC								
1		SF1	SF1A	SF1EC	SF1DEC	1030	4	108.0	82.6	82.50	10	29.8	42.21
	1 1/8	SF1 1/8		SF1 1/8EC	SF1 1/8DEC								
	1 3/16	SF1 3/16		SF1 3/16EC	SF1 3/16DEC								
	1/4	SF1 1/4R	SF1 1/4AR	SF1 1/4ECR	SF1 1/4DEC								
35		SF35	SF35A	SF35EC	SF35DEC	1035	5	117.5	95.3	92.00	12	31.4	46.41
	1 1/4	SF1 1/4	SF1 1/4A	SF1 1/4EC	SF1 1/4DEC								
	1 3/8	SF1 3/8		SF1 3/8EC	SF1 3/8DEC								
	1 7/16	SF1 7/16		SF1 7/16EC	SF1 7/16DEC								
40		SF40	SF40A	SF40EC	SF40DEC	1040	6	130.2	101.6	101.50	12	34.9	54.18
	1 1/2	SF1 1/2	SF1 1/2A	SF1 1/2EC	SF1 1/2DEC								
45		SF45	SF45A	SF45EC	SF45DEC	1045	7	136.5	111.1	105.00	16	35.3	54.18
	1 5/8	SF1 5/8		SF1 5/8EC	SF1 5/8DEC								
	1 11/16	SF1 11/16		SF1 11/16EC	SF1 11/16DEC								
	1 3/4	SF1 3/4	SF1 3/4A	SF1 3/4EC	SF1 3/4DEC								
50		SF50	SF50A	SF50EC	SF50DEC	1050	8	142.9	115.9	111.00	16	39.7	60.53
	1 7/8	SF1 7/8		SF1 7/8EC	SF1 7/8DEC								
	1 15/16	SF1 15/16		SF1 15/16EC	SF1 15/16DEC								
	2	SF2R											
55		SF55			SF55DEC	1055	9	161.9	122.5	130.00	16	43.7	64.31
	2	SF2			SF2DEC								
	2 1/8	SF2 1/8			SF2 1/8DEC								
	2 3/16	SF2 3/16			SF2 3/16DEC								
60		SF60			SF60DEC	1060	10	174.5	135.5	143.00	16	47.6	73.69
	2 1/4	SF2 1/4			SF2 1/4DEC								
	2 3/8	SF2 3/8			SF2 3/8DEC								
	2 7/16	SF2 7/16			SF2 7/16DEC								
65		SF65R				1065	10/65	174.5	149.5	143.00	16	47.6	73.69
	2 1/2	SF2 1/2			SF2 1/2DEC								
65		SF65			SF65DEC	1070	11	187.5	155.5	149.22	16	47.6	77.72
70		SF70			SF70DEC								
	2 5/8	SF2 5/8			SF2 5/8DEC								
	2 11/16	SF2 11/16			SF2 11/16DEC								
75		SF75			SF75DEC	1075	12	196.5	158.5	152.40	20	51.3	80.90
	2 3/4	SF2 3/4			SF2 3/4DEC								
	2 7/8	SF2 7/8			SF2 7/8DEC								
	2 15/16	SF2 15/16			SF2 15/16DEC								
	3	SF3											

Please check availability

Bearing inserts with flinger seals shown on pages 89 and 90 can be fitted into these housings. The unit reference has the suffix 'FS', e.g. SF25FS.

Triple seal bearing inserts shown on pages 86 to 88 can be fitted into these housings. The unit reference has a prefix 'T', e.g. TSF25.

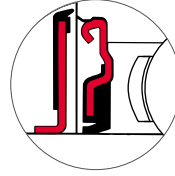

Dimensions (mm)										ISO Load ratings		Rec. max. speed	Mass (approx.)
A ₂	A ₃	A ₄	B	B ₁	B ₂	B ₃	s	s ₁	s ₂	dynamic C _r newtons	static C _{0r} newtons	rev/min	kg
39.01	-	9.5	27.38	-	28.63	-	11.58	6.53	-	9550	4800	7000	0.5
42.42	45.54	11.1	31.00	25.80	31.03	43.73	12.73	7.53	17.13	12800	6650	6700	0.7
42.42	45.95	11.1	34.10	27.30	31.03	44.43	14.33	7.53	17.53	14000	7880	6250	1.0
46.66	50.90	12.7	38.10	31.20	35.73	48.43	15.93	9.03	18.33	19500	11300	5300	1.3
50.34	53.31	12.7	42.90	34.90	38.93	51.13	17.53	9.53	18.83	25700	15300	4500	1.7
56.52	58.90	12.7	49.20	41.20	43.73	56.33	19.03	11.03	21.43	32500	19900	4000	2.2
56.62	58.90	14.3	49.20	41.20	43.73	56.33	19.04	11.04	21.44	32500	20500	3700	2.6
60.60	66.07	14.3	51.60	43.50	43.73	62.73	19.04	11.04	24.64	35000	23200	3400	2.8
-	74.57	17.5	55.60	-	-	71.42	22.24	-	27.84	43500	29200	3100	4.0
-	80.77	17.5	65.10	-	-	77.84	25.44	-	31.04	48000	33000	2800	4.7
-	80.77	18.0	65.10	-	-	85.74	25.44	-	34.14	57500	40000	2600	4.7
-	84.86	18.0	74.60	-	-	85.74	30.24	-	34.14	61000	45000	2450	6.8
-	91.21	23.0	77.80	-	-	92.14	33.34	-	37.34	66000	49500	2300	8.6

Self-Lube[®] cast iron flange bearing units MSF Series

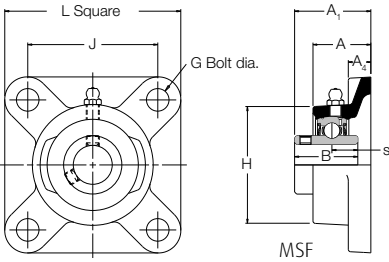

Shaft diameter		RHP designation	Basic bearing insert	Casting group	Dimensions (mm)		
mm	inches				L	H	J
25		MSF25	1030	1	108.0	82.6	82.50
	1	MSF1					
30		MSF30	1035	2	117.5	95.3	92.00
	1 ³ / ₁₆	MSF1 ³ / ₁₆					
	1 ¹ / ₄	MSF1 ¹ / ₄					
35		MSF35	1040	3	130.2	101.6	101.50
	1 ³ / ₈	MSF1 ³ / ₈					
	1 ⁷ / ₁₆	MSF1 ⁷ / ₁₆					
40		MSF40	1045	4	136.5	111.1	105.00
	1 ¹ / ₂	MSF1 ¹ / ₂					
45		MSF45	1050	5	142.9	115.9	111.00
	1 ¹¹ / ₁₆	MSF1 ¹¹ / ₁₆					
	1 ³ / ₄	MSF1 ³ / ₄					
50		MSF50	1055	6	161.9	122.5	130.00
	1 ⁷ / ₈	MSF1 ⁷ / ₈					
	1 ¹⁵ / ₁₆	MSF1 ¹⁵ / ₁₆					
	2	MSF2					
55		MSF55	1060	7	174.5	135.5	143.00
	2 ³ / ₁₆	MSF2 ³ / ₁₆					
	2 ¹ / ₄	MSF2 ¹ / ₄					
60		MSF60	1070	8	187.6	155.5	149.22
	2 ⁷ / ₁₆	MSF2 ⁷ / ₁₆					
	2 ¹ / ₂	MSF2 ¹ / ₂					
65		MSF65	1075	9	196.5	158.5	152.40
70		MSF70					
	2 ¹¹ / ₁₆	MSF2 ¹¹ / ₁₆					
	2 ³ / ₄	MSF2 ³ / ₄					
75		MSF75	1080	10	196.5	173.5	152.40
	2 ¹⁵ / ₁₆	MSF2 ¹⁵ / ₁₆					
	3	MSF3					
80		MSF80	1085	11	213.5	184.0	171.45
	3 ³ / ₁₆	MSF3 ³ / ₁₆					
	3 ¹ / ₄	MSF3 ¹ / ₄					
85		MSF85	1090	12	213.5	196.5	171.45
90		MSF90					
	3 ⁷ / ₁₆	MSF3 ⁷ / ₁₆					
	3 ¹ / ₂	MSF3 ¹ / ₂					
95		MSF95	3095	13	267.5	235.5	211.12
100		MSF100					
	3 ¹⁵ / ₁₆	MSF3 ¹⁵ / ₁₆					
	4	MSF4					

Please check availability

Bearing inserts with flinger seals shown on pages 89 and 90 can be fitted into these housings. The unit reference has the suffix 'FS', e.g. MSF35FS.

Triple seal bearing inserts shown on pages 86 to 88 can be fitted into these housings. The unit reference has a prefix 'T', e.g. TMSF35.

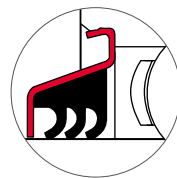
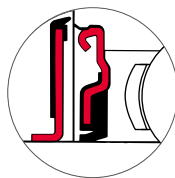

Dimensions (mm)						ISO Load ratings		Rec. max. speed rev/min	Mass (approx.) kg
G	A	A ₁	A ₄	B	s	dynamic C _r newtons	static C _{0r} newtons		
10	29.8	42.21	12.7	38.10	15.93	19500	11300	5300	1.3
12	31.4	46.41	12.7	42.90	17.53	25700	15300	4500	1.7
12	34.9	54.18	12.7	49.20	19.03	32500	19900	4000	2.2
16	35.3	54.18	14.3	49.20	19.04	32500	20500	3700	2.6
16	39.7	60.53	14.3	51.60	19.04	35000	23200	3400	2.8
16	43.7	64.31	17.5	55.60	22.24	43500	29200	3100	4.0
16	47.6	73.69	17.5	65.10	25.44	48000	33000	2800	4.7
16	47.6	77.20	18.0	74.60	30.24	61000	45000	2450	6.8
20	51.3	80.90	23.0	77.80	33.34	66000	49500	2300	8.6
20	55.0	88.87	23.0	82.60	33.34	71500	54500	2150	9.3
20	54.3	89.64	26.0	85.70	34.15	83000	64000	2000	11.1
20	61.7	100.76	26.0	96.00	39.74	96000	71500	1900	13.2
24	83.5	126.95	32.0	117.48	49.31	157000	122000	1600	24.7

Self-Lube[®] cast iron flange bearing units with adapter sleeves

MSF 1000-K Series

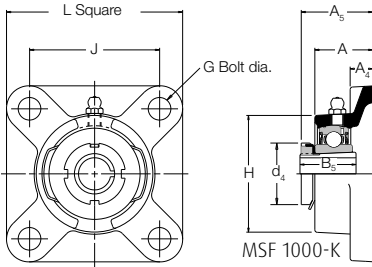

Shaft diameter		RHP designation complete unit	Sleeve nut & lockwasher only	Unit without sleeve, nut & lockwasher	Basic bearing insert	Casting group	Dimensions (mm)		
mm	inches						L	H	J
20		MSF1025-20K	H305	MSF1025K	1025	SF3	95.3	68.0	70.0
	3/4	MSF1025-3/4K	HE3053/4						
25		MSF1030-25K	H306	MSF1030K	1030	1	108.0	82.6	82.5
	15/16	MSF1030-15/16K	HE306-15/16						
	1	MSF1030-1K	HE306-1						
30		MSF1035-30K	H307	MSF1035K	1035	2	117.5	95.3	92.0
	1 1/8	MSF1035-1 1/8K	HE307-1 1/8						
	1 3/16	MSF1035-1 3/16K	HE307-1 3/16						
35		MSF1040-35K	H308	MSF1040K	1040	3	130.2	101.6	101.5
	1 1/4	MSF1040-1 1/4K	HE308-1 1/4						
	1 3/8	MSF1040-1 3/8K	HE308-1 3/8						
40		MSF1045-40K	H309	MSF1045K	1045	4	136.5	111.1	105.0
	1 7/16	MSF1045-1 7/16K	HE309-1 7/16						
	1 1/2	MSF1045-1 1/2K	HE309-1 1/2						
45		MSF1050-45K	H310	MSF1050K	1050	5	142.9	115.9	111.0
	1 11/16	MSF1050-1 11/16K	HE310-1 11/16						
	1 3/4	MSF1050-1 3/4K	HE310-1 3/4						
50		MSF1055-50K	H311	MSF1055K	1055	6	161.9	127.0	130.0
	1 15/16	MSF1055-1 15/16K	HE311-1 15/16						
	2	MSF1055-2K	HE311-2						

Please check availability

G	Dimensions (mm)					ISO Load ratings		Rec. max. speed rev/min	Mass (approx.) kg
	A	A ₄	A ₅	B ₅	d ₄	dynamic C _r newtons	static C _{0r} newtons		
10	28.6	11.1	36.5	29.0	38.0	14000	7880	6250	1.0
10	29.8	12.7	38.0	31.0	45.0	19500	11300	5300	1.3
12	31.4	12.7	40.5	35.0	52.0	25700	15300	4500	1.7
12	34.9	12.7	45.0	36.0	58.0	32500	19900	4000	2.2
16	35.3	14.3	46.5	39.0	65.0	32500	20500	3700	2.6
16	39.7	14.3	52.0	42.0	70.0	35000	23200	3400	2.8
16	43.7	17.5	55.5	45.0	75.0	43500	29200	3100	4.0

Self-Lube® cast iron flange bearing units

SFT Series

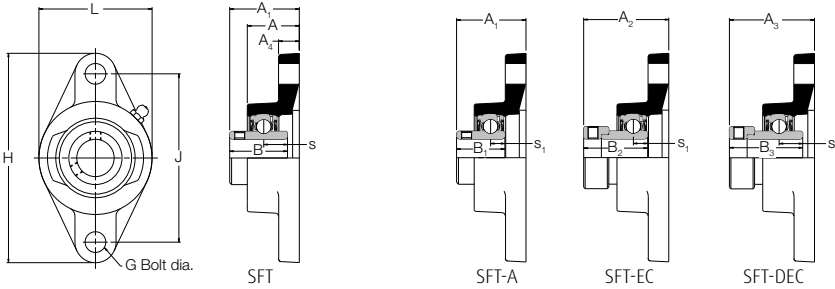

Shaft diameter		RHP designation				Basic bearing insert	Casting group	Dimensions (mm)					
mm	inches							L	H	J	G	A	A ₁
12		SFT12		SFT12EC		1017	1	52.5	98.5	76.50	10	24.6	32.87
15		SFT15		SFT15EC									
16		SFT16		SFT16EC									
17		SFT17		SFT17A									
	1/2	SFT1/2		SFT1/2EC									
	3/8	SFT3/8		SFT3/8EC									
20		SFT20	SFT20A	SFT20EC	SFT20DEC	1020	2	60.3	111.9	90.00	10	27.8	37.26
	3/4	SFT3/4	SFT3/4A	SFT3/4EC	SFT3/4DEC								
25		SFT25	SFT25A	SFT25EC	SFT25DEC	1025	3	70.0	125.5	99.00	10	29.5	38.84
	7/8	SFT7/8		SFT7/8EC	SFT7/8DEC								
	15/16	SFT15/16		SFT15/16EC	SFT15/16DEC								
	1	SFT1	SFT1A	SFT1EC	SFT1DEC								
30		SFT30	SFT30A	SFT30EC	SFT30DEC	1030	4	82.6	141.3	116.50	10	29.8	42.21
	1 1/8	SFT1 1/8		SFT1 1/8EC	SFT1 1/8DEC								
	1 3/16	SFT1 3/16		SFT1 3/16EC	SFT1 3/16DEC								
	1 1/4	SFT1 1/4R	SFT1 1/4AR	SFT1 1/4ECR	SFT1 1/4DEC R								
35		SFT35	SFT35A	SFT35EC	SFT35DEC	1035	5	95.5	155.5	130.00	12	32.0	46.41
	1 1/4	SFT1 1/4	SFT1 1/4A	SFT1 1/4EC	SFT1 1/4DEC								
	1 3/8	SFT1 3/8		SFT1 3/8EC	SFT1 3/8DEC								
	1 7/16	SFT1 7/16		SFT1 7/16EC	SFT1 7/16DEC								
40		SFT40	SFT40A	SFT40EC	SFT40DEC	1040	6	101.6	171.4	143.50	12	34.9	54.18
	1 1/2	SFT1 1/2	SFT1 1/2A	SFT1 1/2EC	SFT1 1/2DEC								
45		SFT45	SFT45A	SFT45EC	SFT45DEC	1045	7	111.1	179.4	148.50	16	35.3	54.18
	1 5/8	SFT1 5/8		SFT1 5/8EC	SFT1 5/8DEC								
	1 11/16	SFT1 11/16		SFT1 11/16EC	SFT1 11/16DEC								
	1 3/4	SFT1 3/4	SFT1 3/4A	SFT1 3/4EC	SFT1 3/4DEC								
50		SFT50	SFT50A	SFT50EC	SFT50DEC	1050	8	115.9	188.9	157.00	16	39.7	60.53
	1 7/8	SFT1 7/8		SFT1 7/8EC	SFT1 7/8DEC								
	1 15/16	SFT1 15/16		SFT1 15/16EC	SFT1 15/16DEC								
	2	SFT2R											
55		SFT55			SFT55DEC	1055	9	127.0	215.9	184.00	16	43.7	64.31
	2	SFT2			SFT2DEC								
	2 1/8	SFT2 1/8			SFT2 1/8DEC								
	2 3/16	SFT2 3/16			SFT2 3/16DEC								
60		SFT60			SFT60DEC	1060	10	138.1	235.0	202.00	16	47.6	73.69
	2 1/4	SFT2 1/4			SFT2 1/4DEC								
	2 3/8	SFT2 3/8			SFT2 3/8DEC								
	2 7/16	SFT2 7/16			SFT2 7/16DEC								

Please check availability

Bearing inserts with flinger seals shown on pages 89 and 90 can be fitted into these housings. The unit reference has the suffix 'FS', e.g. SFT25FS.

Triple seal bearing inserts shown on pages 86 to 88 can be fitted into these housings. The unit reference has a prefix 'T', e.g. TSFT25.

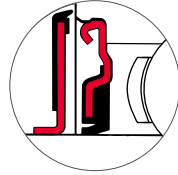

Dimensions (mm)											ISO Load ratings		Rec. max. speed rev/min	Mass (approx.) kg
A ₂	A ₃	A ₄	B	B ₁	B ₂	B ₃	s	s ₁	s ₂	dynamic C _r newtons	static C _r newtons			
39.01	-	9.5	27.38	-	28.63	-	11.58	6.53	-	9550	4800	7000	0.4	
42.42	45.54	11.1	31.00	25.80	31.03	43.73	12.73	7.53	17.13	12800	6650	6700	0.6	
42.42	45.95	11.5	34.10	27.30	31.03	44.43	14.33	7.53	17.53	14000	7880	6520	0.9	
46.66	50.09	12.7	38.10	31.20	35.73	48.43	15.93	9.03	18.33	19500	11300	5300	1.1	
50.34	53.34	13.0	42.90	34.90	38.93	51.13	17.53	9.53	18.83	25700	15300	4500	1.4	
56.62	58.90	12.7	49.20	41.20	43.73	56.33	19.03	11.03	21.43	32500	19900	4000	1.9	
56.62	58.90	14.3	49.20	41.20	43.73	56.33	19.04	11.04	21.44	32500	20500	3700	2.2	
60.60	66.07	14.3	51.60	43.50	43.73	62.73	19.04	11.04	24.64	35000	23200	3400	2.5	
-	74.57	17.5	55.60	-	-	71.42	22.24	-	27.84	43500	29200	3100	3.5	
-	80.77	17.5	65.10	-	-	77.84	25.44	-	31.04	48000	33000	2800	4.3	

Self-Lube® cast iron flange bearing units

MSFT Series

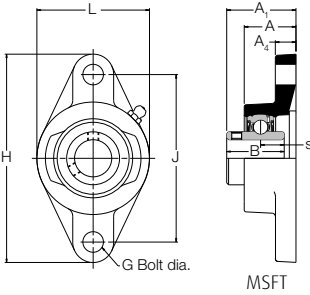

Shaft diameter		RHP designation	Basic bearing insert	Casting group	Dimensions (mm)		
mm	inches				L	H	J
25		MSFT25	1030	1	82.6	141.3	116.50
	1	MSFT1					
30		MSFT30	1035	2	95.5	155.5	130.00
	1 ³ / ₁₆	MSFT1 ³ / ₁₆					
	1 ¹ / ₄	MSFT1 ¹ / ₄					
35		MSFT35	1040	3	101.6	171.4	143.50
	1 ³ / ₈	MSFT1 ³ / ₈					
	1 ⁷ / ₁₆	MSFT1 ⁷ / ₁₆					
40		MSFT40	1045	4	111.1	179.4	148.50
	1 ¹ / ₂	MSFT1 ¹ / ₂					
45		MSFT45	1050	5	115.9	188.9	157.00
	1 ¹¹ / ₁₆	MSFT1 ¹¹ / ₁₆					
	1 ³ / ₄	MSFT1 ³ / ₄					
50		MSFT50	1055	6	127.0	215.9	184.00
	1 ⁷ / ₈	MSFT1 ⁷ / ₈					
	1 ¹⁵ / ₁₆	MSFT1 ¹⁵ / ₁₆					
	2	MSFT2					
55		MSFT55	1060	7	138.1	235.0	202.00
	2 ¹ / ₁₆	MSFT2 ¹ / ₁₆					

Please check availability

Bearing inserts with flinger seals shown on pages 89 and 90 can be fitted into these housings. The unit reference has the suffix 'FS', e.g. MSFT40FS.

Triple seal bearing inserts shown on pages 86 to 88 can be fitted into these housings. The unit reference has a prefix 'T', e.g. TMSFT40.

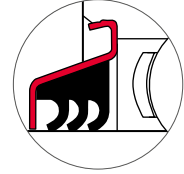
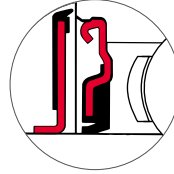

Dimensions (mm)						ISO Load ratings		Rec. max. speed rev/min	Mass (approx.) kg
G	A	A ₁	A ₄	B	s	dynamic C _r newtons	static C _{0r} newtons		
10	29.8	42.21	12.7	38.10	15.93	19500	11300	5300	1.1
12	32.0	46.41	13.0	42.90	17.53	25700	15300	4500	1.4
12	34.9	54.18	12.7	49.20	19.03	32500	19900	4000	1.9
16	35.3	54.18	14.3	49.20	19.04	32500	20500	3700	2.2
16	39.7	60.53	14.3	51.60	19.04	35000	23200	3400	2.5
16	43.7	64.31	17.5	55.60	22.24	43500	29200	3100	3.5
16	47.6	73.69	17.5	65.10	25.44	48000	33000	2800	4.3

Self-Lube[®] cast iron flange bearing units with adapter sleeves

MSFT 1000-K Series

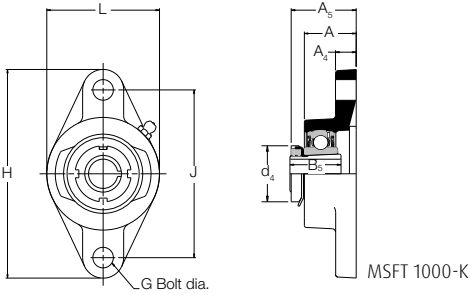

Shaft diameter		RHP designation complete unit	Sleeve nut & lockwasher only	Unit without sleeve, nut & lockwasher	Basic bearing insert	Casting group	Dimensions (mm)		
mm	inches						L	H	J
20		MSFT1025-20K	H305	MSFT1025K	1025	SFT3	68.3	123.8	99.0
	3/4	MSFT1025-3/4K	HE305-3/4						
25		MSFT1030-25K	H306	MSFT1030K	1030	1	82.6	141.3	116.5
	15/16	MSFT1030-15/16K	HE306-15/16						
	1	MSFT1030-1K	HE306-1						
30		MSFT1035-30K	H307	MSFT1035K	1035	2	95.5	155.5	130.0
	1 1/8	MSFT1035-1 1/8K	HE307-1 1/8						
	1 3/16	MSFT1035-1 3/16K	HE307-1 3/16						
35		MSFT1040-35K	H308	MSFT1040K	1040	3	101.6	171.4	143.5
	1 1/4	MSFT1040-1 1/4K	HE308-1 1/4						
	1 3/8	MSFT1040-1 3/8K	HE308-1 3/8						
40		MSFT1045-40K	H309	MSFT1045K	1045	4	111.1	179.4	148.5
	1 7/16	MSFT1045-1 7/16K	HE309-1 7/16						
	1 1/2	MSFT1045-1 1/2K	HE309-1 1/2						
45		MSFT1050-45K	H310	MSFT1050K	1050	5	115.9	188.9	157.0
	1 11/16	MSFT1050-1 11/16K	HE310-1 11/16						
	1 3/4	MSFT1050-1 3/4K	HE310-1 3/4						
50		MSFT1055-50K	H311	MSFT1055K	1055	6	127.0	215.9	184.0
	1 15/16	MSFT1055-1 15/16K	HE311-1 15/16						
	2	MSFT1055-2K	HE311-2						

Please check availability

G	Dimensions (mm)					ISO Load ratings		Rec. max. speed rev/min	Mass (approx.) kg
	A	A ₄	A ₅	B ₅	d ₄	dynamic C _r newtons	static C ₀ or newtons		
10	28.6	11.1	36.5	29.0	38.0	14000	7880	6250	0.9
10	29.8	12.7	38.0	31.0	45.0	19500	11300	5300	1.1
12	32.0	12.7	40.5	35.0	52.0	25700	15300	4500	1.4
12	34.9	12.7	45.0	36.0	58.0	32500	19900	4000	1.9
16	35.3	14.3	46.5	39.0	65.0	32500	20500	3700	2.2
16	39.7	14.3	52.0	42.0	70.0	35000	23200	3400	2.5
16	43.7	17.5	55.5	45.0	75.0	43500	29200	3100	3.5

Self-Lube[®] cast iron flange bearing units

LFTC Series

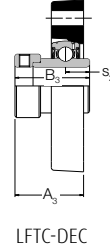
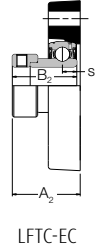
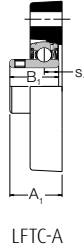
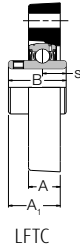
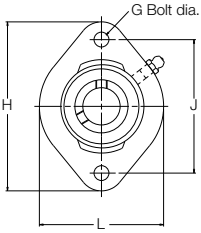

Shaft diameter		RHP designation				Basic bearing insert	Casting group	Dimensions (mm)				
mm	inches							L	H	J	G	A
12		LFTC12		LFTC12EC		1017	1	58.5	81.0	63.5	6.0	15.0
15		LFTC15		LFTC15EC								
16		LFTC16		LFTC16EC								
17		LFTC17		LFTC17EC								
1/2		LFTC1/2		LFTC1/2EC								
5/8		LFTC5/8		LFTC5/8EC								
20		LFTC20	LFTC20A	LFTC20EC	LFTC20DEC	1020	2	66.5	90.5	71.5	8.0	17.0
3/4		LFTC3/4	LFTC3/4A	LFTC3/4EC	LFTC3/4DEC							
25		LFTC25	LFTC25A	LFTC25EC	LFTC25DEC	1025	3	71.0	96.0	76.0	8.0	17.5
7/8		LFTC7/8		LFTC7/8EC	LFTC7/8DEC							
15/16		LFTC15/16		LFTC15/16EC	LFTC15/16DEC							
1		LFTC1	LFTC1A	LFTC1EC	LFTC1DEC							
30		LFTC30	LFTC30A	LFTC30EC	LFTC30DEC	1030	4	84.0	112.0	90.5	10.0	20.5
1 1/8		LFTC1 1/8		LFTC1 1/8EC	LFTC1 1/8DEC							
1 3/16		LFTC1 3/16		LFTC1 3/16EC	LFTC1 3/16DEC							
1 1/4		LFTC1 1/4	LFTC1 1/4A	LFTC1 1/4EC	LFTC1 1/4DEC							
35		LFTC35	LFTC 35A	LFTC35EC	LFTC35DEC	1035	5	91.3	123.3	100.0	10.0	22.0
1 1/4		LFTC1 1/4L	LFTC1 1/4AL	LFTC1 1/4ECL	LFTC1 1/4DECL							
1 3/8		LFTC1 3/8		LFTC1 3/8EC	LFTC1 3/8DEC							
1 7/16		LFTC1 7/16		LFTC1 7/16EC	LFTC1 7/16DEC							

Please check availability

Bearing inserts with flinger seals shown on pages 89 and 90 can be fitted into these housings. The unit reference has the suffix 'FS', e.g. LFTC 7/8 FS.

Triple seal bearing inserts shown on pages 86 to 88 can be fitted into these housings. The unit reference has a prefix 'T', e.g. TLFTC 7/8.

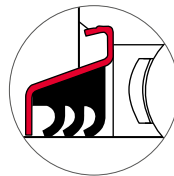
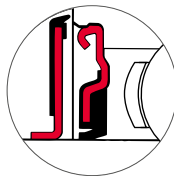

Dimensions (mm)										ISO Load ratings		Rec. max. speed	Mass (approx.)
A ₁	A ₂	A ₃	B	B ₁	B ₂	B ₃	s	s ₁	s ₂	dynamic C _r newtons	static C _{or} newtons	rev/min	kg
24.27	30.43	-	27.38	-	28.63	-	11.58	6.53	-	9550	4800	7000	0.3
27.76	32.92	36.04	31.00	25.80	31.03	43.73	12.73	7.53	17.13	12800	6650	6700	0.4
29.24	32.82	36.35	34.00	27.30	31.03	44.43	14.33	7.53	17.53	14000	7880	6250	0.5
33.62	38.07	41.50	38.10	31.20	35.73	48.43	15.93	9.03	18.33	19500	11300	5300	0.8
37.80	41.74	44.71	42.90	34.90	38.93	51.13	17.53	9.53	18.83	25700	15300	4500	1.1

Self-Lube® cast iron flange cartridge bearing units FC Series

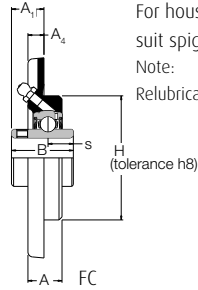
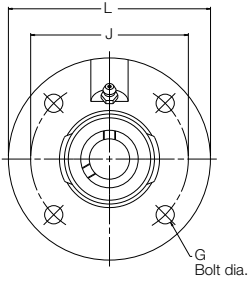

For housing tolerances to suit spigot 'H' see page 19
Note:
Relubrication hole - M5 x 0.8 pitch

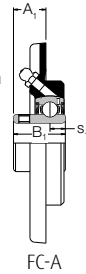

FC-A

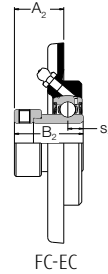

FC-EC

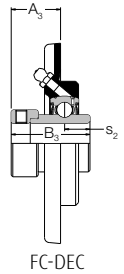

FC-DEC

Shaft diameter		RHP designation				Basic bearing insert	Casting group	Dimensions (mm)					
mm	inches							L	H	J	G	A	A ₁
20		FC20	FC20A	FC20EC	FC20DEC	1020	2	100.0	62.0	78.0	8	17.0	16.29
		FC3/4	FC3/4A	FC3/4EC	FC3/4DEC								
25		FC25	FC25A	FC25EC	FC25DEC	1025	3	115.0	70.0	90.0	8	19.0	17.34
		FC7/8		FC7/8EC	FC7/8DEC								
		FC1 ⁵ / ₁₆		FC1 ⁵ / ₁₆ EC	FC1 ⁵ / ₁₆ DEC								
		FC1	FC1A	FC1EC	FC1DEC								
30		FC30	FC30A	FC30EC	FC30DEC	1030	4	125.0	80.0	100.0	10	20.5	20.22
		FC1 ¹ / ₈		FC1 ¹ / ₈ EC	FC1 ¹ / ₈ DEC								
		FC1 ¹ / ₁₆		FC1 ¹ / ₁₆ EC	FC1 ¹ / ₁₆ DEC								
		FC1 ¹ / ₄ AR	FC1 ¹ / ₄ AR	FC1 ¹ / ₄ ECR	FC1 ¹ / ₄ DEC								
35		FC35	FC35A	FC35EC	FC35DEC	1035	5	135.0	90.0	110.0	10	20.5	24.40
		FC1 ¹ / ₄	FC1 ¹ / ₄ A	FC1 ¹ / ₄ EC	FC1 ¹ / ₄ DEC								
		FC1 ³ / ₈		FC1 ³ / ₈ EC	FC1 ³ / ₈ DEC								
		FC1 ⁷ / ₁₆		FC1 ⁷ / ₁₆ EC	FC1 ⁷ / ₁₆ DEC								
40		FC40	FC40A	FC40EC	FC40DEC	1040	6	145.0	100.0	120.0	10	23.0	29.18
		FC1 ¹ / ₂	FC1 ¹ / ₂ A	FC1 ¹ / ₂ EC	FC1 ¹ / ₂ DEC								
45		FC45	FC45A	FC45EC	FC45DEC	1045	7	155.0	105.0	130.0	12	25.0	28.18
		FC1 ⁵ / ₈		FC1 ⁵ / ₈ EC	FC1 ⁵ / ₈ DEC								
		FC1 ¹¹ / ₁₆		FC1 ¹¹ / ₁₆ EC	FC1 ¹¹ / ₁₆ DEC								
		FC1 ³ / ₄	FC1 ³ / ₄ A	FC1 ³ / ₄ EC	FC1 ³ / ₄ DEC								
50		FC50	FC50A	FC50EC	FC50DEC	1050	8	165.0	110.0	135.0	12	25.0	31.52
		FC1 ⁷ / ₈		FC1 ⁷ / ₈ EC	FC1 ⁷ / ₈ DEC								
		FC1 ¹⁵ / ₁₆		FC1 ¹⁵ / ₁₆ EC	FC1 ¹⁵ / ₁₆ DEC								
		FC2R											
55		FC55		FC55DEC		1055	9	185.0	125.0	150.0	16	27.5	33.30
		FC2		FC2DEC									
		FC2 ¹ / ₈		FC2 ¹ / ₈ DEC									
		FC2 ³ / ₁₆		FC2 ³ / ₁₆ DEC									
60		FC60		FC60DEC		1060	10	195.0	135.0	160.0	16	29.0	38.65
		FC2 ¹ / ₄		FC2 ¹ / ₄ DEC									
		FC2 ³ / ₈		FC2 ³ / ₈ DEC									
		FC2 ⁷ / ₁₆		FC2 ⁷ / ₁₆ DEC									

Please check availability

Bearing inserts with flinger seals shown on pages 89 and 90 can be fitted into these housings. The unit reference has the suffix 'FS', e.g. FC40FS.

Triple seal bearing inserts shown on pages 86 to 88 can be fitted into these housings. The unit reference has a prefix 'T', e.g. TFC40.

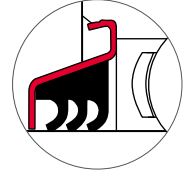
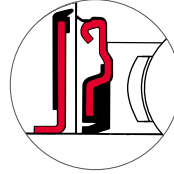

Dimensions (mm)											ISO Load ratings		Rec. max. speed rev/min	Mass (approx.) kg
A ₂	A ₃	A ₄	B	B ₁	B ₂	B ₃	s	s ₁	s ₂	dynamic C _r newtons	static C _{0r} newtons			
21.45	24.57	8.00	31.00	25.80	31.03	43.73	12.73	7.53	17.13	12800	6650	6700	0.7	
20.86	24.41	9.00	34.10	27.30	31.03	44.43	14.33	7.53	17.53	14000	7880	6250	0.9	
24.64	28.10	9.50	38.10	31.20	35.73	48.43	15.93	9.03	18.33	19500	11300	5300	1.1	
28.33	31.29	10.00	42.90	34.90	38.93	51.13	17.53	9.53	18.83	25700	15300	4500	1.5	
31.59	33.88	11.50	49.20	41.20	43.73	56.33	19.03	11.03	21.43	32500	19900	4000	1.8	
30.59	32.88	12.00	49.20	41.20	43.73	56.33	19.04	11.03	21.43	32500	20500	3700	2.2	
31.63	37.14	13.00	51.60	43.50	43.73	62.73	19.04	11.04	24.64	35000	23200	3400	2.8	
-	43.72	15.00	55.60	-	-	71.42	22.24	-	27.84	43500	29200	3100	4.0	
-	45.89	16.00	65.10	-	-	77.84	25.44	-	31.04	48000	33000	2800	4.7	

Self-Lube® cast iron flange cartridge bearing units MFC Series

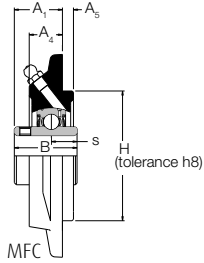
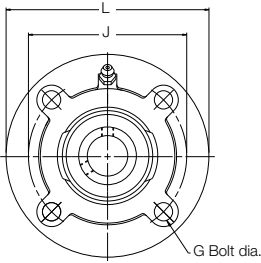

For housing tolerances to suit spigot 'H' see page 19

Shaft diameter		RHP designation	Basic bearing insert	Casting group	Dimensions (mm)		
mm	inches				L	H	J
25		MFC25	1030	1	111.1	76.2	92.1
	1	MFC1				3"	
30	1¼	MFC1¼R	1035	2	127.0	85.7	104.8
	1⅜	MFC1⅜				3⅜"	
	1½	MFC1½					
35		MFC35	1040	3	133.4	92.1	111.1
	40	MFC40				3⅝"	
	1⅝	MFC1⅝					
	1⅞	MFC1⅞					
45		MFC45	1050	4	155.6	108.0	130.2
	1⅞	MFC1⅞				4¼"	
	1¾	MFC1¾					
	2	MFC2R					
50		MFC50	1055	5	161.9	114.3	136.5
	1⅞	MFC1⅞				4½"	
	1⅞	MFC1⅞					
	2	MFC2					
55		MFC55	1060	6	181.0	127.0	152.4
	2⅜	MFC2⅜				5"	
	2¼	MFC2¼					
60		MFC60	1070	7	193.7	139.7	165.1
65		MFC65R				5½"	
	2⅞	MFC2⅞					
65		MFC65	1075	8	222.2	161.9	190.5
	70	MFC70				6⅜"	
75		MFC75	1080	9	222.2	161.9	190.5
	2⅞	MFC2⅞				6⅝"	
	3	MFC3					
80		MFC80	1090	10	260.4	187.3	219.1
	2⅞	MFC2⅞				7⅝"	
	3¼	MFC3¼					
85		MFC85	1090	10	260.4	187.3	219.1
	90	MFC90				7⅝"	
	3⅞	MFC3⅞					
95		MFC95	3095	11	298.4	228.6	260.4
	100	MFC100				5"	
100	3⅞	MFC3⅞	3095	11	298.4	228.6	260.4
	4	MFC4					

Please check availability

Bearing inserts with flinger seals shown on pages 89 and 90 can be fitted into these housings. The unit reference has the suffix 'FS', e.g. MFC30FS.

Triple seal bearing inserts shown on pages 86 to 88 can be fitted into these housings. The unit reference has a prefix 'T', e.g. TMFC30.

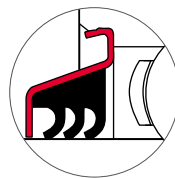
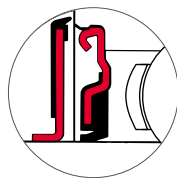

G	Dimensions (mm)					ISO Load ratings		Rec. max. speed rev/min	Mass kg
	A ₁	A ₄	A ₅	B	s	dynamic C _r newtons	static C _{0r} newtons		
8	33.32	21.0	6.4	38.10	15.93	19500	11300	5300	1.4
10	33.32	19.0	6.4	42.90	17.53	25700	15300	4500	1.5
10	38.10	19.0	6.4	49.20	19.03	32500	19900	4000	1.9
10	39.67	19.0	6.4	51.60	19.04	35000	23200	3400	2.7
10	39.67	19.0	6.4	55.60	22.24	43500	29200	3100	3.0
12	42.85	15.9	9.5	65.10	25.44	48000	33000	2800	3.4
12	46.02	15.9	12.7	74.60	30.24	61000	45000	2450	4.5
16	50.80	21.0	12.7	77.80	33.34	66000	49500	2300	5.9
16	50.80	16.7	12.7	82.60	33.34	71500	54500	2150	5.4
20	67.46	29.4	12.7	96.00	39.74	96000	71500	1900	9.8
20	88.90	46.0	12.7	117.48	49.31	157000	122000	1600	17.7

Self-Lube® cast iron take-up bearing units

ST Series

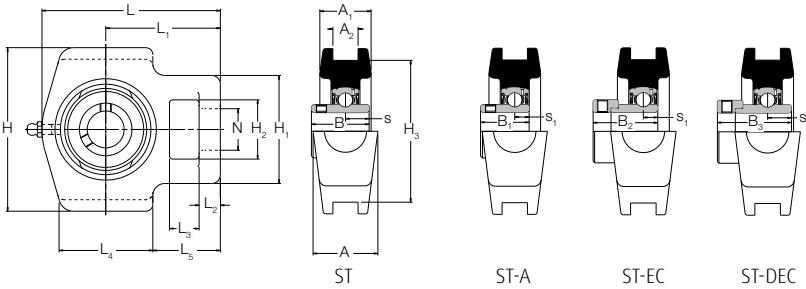

Shaft diameter		RHP designation				Basic bearing insert	Casting group	Dimensions (mm)							
mm	inches							L	L ₁	L ₂	L ₃	L ₄	L ₅	H	
20		ST20	ST20A	ST20EC	ST20DEC	1020	2	95.5	62.0	11.5	16.0	50.5	36.5	88.5	
		3/4	ST13/4	ST13/4A	ST13/4EC										ST13/4DEC
25		ST25	ST25A	ST25EC	ST25DEC	1025	3	98.0	62.0	11.5	16.0	50.5	36.5	88.5	
		7/8	ST7/8		ST7/8EC										ST7/8DEC
		15/16	ST15/16		ST15/16EC										ST15/16DEC
30		ST1	ST1A	ST1EC	ST1DEC	1030	4	115.5	72.5	12.5	16.5	64.5	43.0	101.5	
		1	ST130	ST130A	ST130EC										ST130DEC
		1 1/8	ST11 1/8		ST11 1/8EC										ST11 1/8DEC
		1 3/16	ST11 3/16		ST11 3/16EC										ST11 3/16DEC
35		ST1 1/4R	ST1 1/4AR	ST1 1/4ECR	ST1 1/4DEC	1035	5	124.0	75.5	12.5	16.5	64.5	43.0	101.5	
		1 1/4	ST135	ST135A	ST135EC										ST135DEC
		1 1/4	ST11 1/4	ST11 1/4A	ST11 1/4EC										ST11 1/4DEC
		1 3/8	ST11 3/8		ST11 3/8EC										ST11 3/8DEC
40		ST17/16		ST17/16EC	ST17/16DEC	1040	6	143.5	89.2	15.5	20.5	81.5	50.5	118.0	
		1 1/2	ST140	ST140A	ST140EC										ST140DEC
		1 1/2	ST11 1/2	ST11 1/2A	ST11 1/2EC										ST11 1/2DEC
45		ST45	ST45A	ST45EC	ST45DEC	1045	7	147.0	89.2	15.5	20.5	81.5	50.5	118.0	
		1 5/8	ST11 5/8		ST11 5/8EC										ST11 5/8DEC
		1 11/16	ST11 11/16		ST11 11/16EC										ST11 11/16DEC
		1 3/4	ST11 3/4	ST11 3/4A	ST11 3/4EC										ST11 3/4DEC
50		ST150	ST150	ST150EC	ST150DEC	1050	8	151.0	90.5	15.5	20.5	81.5	50.5	118.0	
		1 7/8	ST11 7/8		ST11 7/8EC										ST11 7/8DEC
		1 15/16	ST11 15/16		ST11 15/16EC										ST11 15/16DEC
55		ST12R				1055	9	182.0	114.0	19.0	32.0	97.5	70.0	146.0	
		2	ST55		ST55DEC										ST55DEC
		2	ST2		ST2DEC										ST2DEC
		2 1/8	ST2 1/8		ST2 1/8DEC										ST2 1/8DEC
		2 3/16	ST2 3/16		ST2 3/16DEC										ST2 3/16DEC
60		ST60		ST60DEC	ST60DEC	1060	10	192.0	119.0	19.0	32.0	97.5	70.0	146.0	
		2 1/4	ST2 1/4		ST2 1/4DEC										ST2 1/4DEC
		2 3/8	ST2 3/8		ST2 3/8DEC										ST2 3/8DEC
		2 7/16	ST2 7/16		ST2 7/16DEC										ST2 7/16DEC
			ST65		ST65DEC										ST65DEC
65		ST65		ST65DEC	ST65DEC	1070	11	222.5	137.5	21.5	32.0	120.5	77.0	166.5	
		70	ST70		ST70DEC										ST70DEC
70		ST70		ST70DEC	ST70DEC	1070	11	222.5	137.5	21.5	32.0	120.5	77.0	166.5	
		2 1/2	ST2 1/2		ST2 1/2DEC										ST2 1/2DEC
		2 11/16	ST2 11/16		ST2 11/16EC										ST2 11/16DEC
75		ST75		ST75DEC	ST75DEC	1075	12	222.5	137.5	21.5	32.0	120.5	77.0	166.5	
		2 3/4	ST2 3/4		ST2 3/4DEC										ST2 3/4DEC
		2 7/8	ST2 7/8		ST2 7/8DEC										ST2 7/8DEC
		2 15/16	ST2 15/16		ST2 15/16EC										ST2 15/16DEC
80		ST80				1080	13	231.5	139.5	20.5	32.0	125.0	74.0	184.0	
		3	ST3												
		3 3/16	ST3 3/16												
85		ST85				1085	14	260.5	162.0	28.5	38.0	140.0	90.5	198.5	
		3 1/4	ST3 1/4												
		3 3/8	ST3 3/8												
		3 7/16	ST3 7/16												

Please check availability

Bearing inserts with flinger seals shown on pages 89 and 90 can be fitted into these housings. The unit reference has the suffix 'FS', e.g. ST45FS.

Triple seal bearing inserts shown on pages 86 to 88 can be fitted into these housings. The unit reference has a prefix 'T', e.g. TST45.

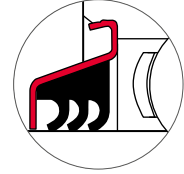
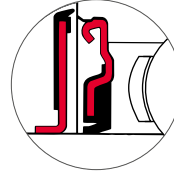

Dimensions (mm)														ISO Load ratings		Rec. max. speed	Mass (approx.)
H ₁	H ₂	H ₃	N	A	A ₁	A ₂	B	B ₁	B ₂	B ₃	s	s ₁	s ₂	dynamic C _r newtons	static C _{0r} newtons	rev/min	kg
58.5	32.0	76.0	22.5	36.0	27.5	13.50	31.00	25.80	31.03	43.73	12.73	7.53	17.13	12800	6650	6700	0.8
58.5	32.0	76.0	22.5	36.0	27.5	13.50	34.10	27.30	31.03	44.43	14.33	7.53	17.53	14000	7880	6250	1.0
64.5	37.5	89.0	22.5	36.5	30.0	13.50	38.10	31.20	35.73	48.43	15.93	9.03	18.33	19500	11300	5300	1.6
64.5	37.5	89.0	22.5	36.5	30.0	13.50	42.90	34.90	38.93	51.13	17.53	9.53	18.83	25700	15300	4500	1.6
82.5	49.5	101.0	29.0	49.5	37.0	17.50	49.20	41.20	43.73	56.33	19.03	11.03	21.43	32500	19900	4000	2.7
82.5	49.5	101.0	29.0	49.5	37.0	17.50	49.20	41.20	43.73	56.33	19.04	11.03	21.43	32500	20500	3700	2.8
82.5	49.5	101.0	29.0	49.5	37.0	17.50	51.60	43.50	43.73	62.73	19.04	11.03	24.64	35000	23200	3400	2.8
101.0	64.0	130.0	35.0	63.5	46.5	27.00	55.60	-	-	71.42	22.24	-	27.84	43500	29200	3100	4.2
101.0	64.0	130.0	35.0	63.5	46.5	27.00	65.10	-	-	77.84	25.44	-	31.04	48000	33000	2800	5.4
113.0	70.0	150.8	42.0	70.0	50.5	27.00	74.60	-	-	85.74	30.24	-	34.14	61000	45000	2450	7.9
113.0	70.0	150.8	42.0	70.0	50.5	27.00	77.80	-	-	92.14	33.34	-	37.34	66000	49500	2300	8.4
113.0	70.0	165.1	42.0	70.0	54.0	27.00	82.60	-	-	-	33.34	-	-	71500	54500	2150	9.0
124.0	73.0	173.0	47.5	79.5	68.5	46.05	85.70	-	-	-	34.15	-	-	83000	64000	2000	13.7

Self-Lube® cast iron take-up bearing units

MST Series

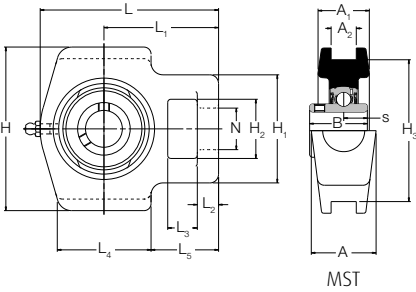

Shaft diameter		RHP designation	Basic bearing insert	Casting group	Dimensions (mm)					
mm	inches				L	L ₁	L ₂	L ₃	L ₄	L ₅
25		MST25	1030	1	115.5	72.5	12.5	16.5	64.5	43.0
	1	MST1								
30		MST30	1035	2	124.0	75.5	12.5	16.5	64.5	43.0
	1 3/16	MST1 3/16								
	1 1/4	**								
35		MST35	1040	3	143.5	89.2	15.5	20.5	81.5	50.5
	1 3/8	MST1 3/8								
	1 7/16	MST1 7/16								
40		MST40	1045	4	147.0	89.2	15.5	20.5	81.5	50.5
	1 1/2	MST1 1/2								
45		MST45	1050	5	151.0	90.5	15.5	20.5	81.5	50.5
	1 11/16	MST1 11/16								
	1 3/4	MST1 3/4								
50		MST50	1055	6	182.0	114.0	19.0	32.0	97.5	70.0
	1 7/8	MST1 7/8								
	1 15/16	MST1 15/16								
	2	**								
55		MST55	1060	7	192.0	119.0	19.0	32.0	97.5	70.0
	2 1/16	MST2 1/16								
	2 1/4	**								
60		MST60	1070	8	222.5	137.5	21.5	32.0	120.5	77.0
	2 3/16	MST2 3/16								
	2 1/2	**								
65		MST65	1075	9	222.5	137.5	21.5	32.0	120.5	77.0
70		MST70								
	2 11/16	MST2 11/16								
	2 3/4	**								
75		MST75	1080	10	231.5	139.5	20.5	32.0	125.0	74.0
	2 15/16	MST2 15/16								
	3	**								
80		MST80	1085	11	260.5	162.0	28.5	38.0	140.0	90.5
	3 1/16	MST3 1/16								
	3 1/4	**								
85		MST85	1090	12	270.0	165.0	28.5	38.0	152.5	90.0
90		MST90								
	3 7/16	MST3 7/16								
	3 1/2	MST3 1/2								
95		MST95	3095	13	317.5	190.5	32.0	38.0	175.0	103.0
100		MST100								
	3 15/16	MST3 15/16								
	4	MST4								

Please check availability

** For these bore sizes select from ST series (see page 54)

Bearing inserts with flinger seals shown on pages 89 and 90 can be fitted into these housings. The unit reference has the suffix 'FS', e.g. MST35FS.

Triple seal bearing inserts shown on pages 86 to 88 can be fitted into these housings. The unit reference has a prefix 'T', e.g. TMST35.

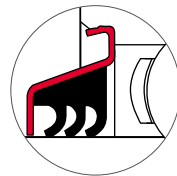
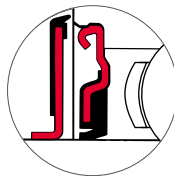

Dimensions (mm)										ISO Load ratings		Rec. max. speed	Mass (approx.)
H	H ₁	H ₂	H ₃	N	A	A ₁	A ₂	B	s	dynamic C _r newtons	static C _r or newtons	rev/min	kg
101.5	64.5	37.5	89.0	22.5	36.5	30.0	13.50	38.10	15.93	19500	11300	5300	1.6
101.5	64.5	37.5	89.0	22.5	36.5	30.0	13.50	42.90	17.53	25700	15300	4500	1.6
118.0	82.5	49.5	101.0	29.0	49.5	37.0	17.50	49.20	19.03	32500	19900	4000	2.7
118.0	82.5	49.5	101.0	29.0	49.5	37.0	17.50	49.20	19.04	32500	20500	3700	2.8
118.0	82.5	49.5	101.0	29.0	49.5	37.0	17.50	51.60	19.04	35000	23200	3400	2.8
146.0	101.0	64.0	130.0	35.0	63.5	46.5	27.00	55.60	22.24	43500	29200	3100	4.2
146.0	101.0	64.0	130.0	35.0	63.5	46.5	27.00	65.10	25.44	48000	33000	2800	5.4
166.5	113.0	70.0	150.8	42.0	70.0	50.5	27.00	74.60	30.24	61000	45000	2450	7.9
166.5	113.0	70.0	150.8	42.0	70.0	50.5	27.00	77.80	33.34	66000	49500	2300	8.4
184.0	113.0	70.0	165.1	42.0	70.0	54.0	27.00	82.60	33.34	71500	54500	2150	9.0
198.5	124.0	73.0	173.0	47.5	79.5	68.5	46.05	85.70	34.15	83000	64000	2000	13.7
216.0	127.0	73.0	190.5	47.5	79.5	69.5	46.05	96.00	39.74	96000	71500	1900	16.8
260.5	152.5	85.5	235.0	54.5	98.5	83.0	55.55	117.48	49.31	157000	122000	1600	22.2

Self-Lube® cast iron take-up bearing units with adapter sleeves

MST 1000-K Series

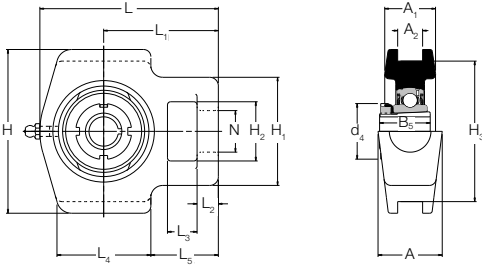

MST1000-K

Shaft diameter		RHP designation complete unit	Sleeve, nut & lockwasher only	Units without sleeve, nut & lockwasher	Basic bearing	Casting group insert	Dimensions (mm)					
							L	L ₁	L ₂	L ₃	L ₄	L ₅
mm	inches											
20		MST1025-20K	H305	MST1025K	1025	ST3	98.0	62.0	11.5	16.0	50.5	36.5
	¾	MST1025-¾K	HE305-¾									
25		MST1030-25K	H306	MST1030K	1030	1	115.5	71.7	12.5	16.5	64.5	43.0
	1	MST1030-1K	HE306-1									
30		MST1035-30K	H307	MST1035K	1035	2	124.0	75.5	12.5	16.5	64.5	43.0
	1½	MST1035-1½K	HE307-1½									
35		MST1040-35K	H308	MST1040K	1040	3	143.5	89.2	15.5	20.5	81.5	50.5
	1¼	MST1040-1¼K	HE308-1¼									
40		MST1045-40K	H309	MST1045K	1045	4	147.0	89.2	15.5	20.5	81.5	50.5
	1½	MST1045-1½K	HE309-1½									
45		MST1050-45K	H310	MST1050K	1050	5	151.0	90.5	15.5	20.5	81.5	50.5
	1¾	MST1050-1¾K	HE310-1¾									
50		MST1055-50K	H311	MST1055K	1055	6	182.0	114.0	19.0	32.0	97.5	70.0
	2	MST1055-2K	HE3011-2									

Please check availability

Dimensions (mm)										ISO Load ratings		Rec max. speed rev/min	Mass (approx.) kg
H	H ₁	H ₂	H ₃	N	A	A ₁	A ₂	B ₅	d ₄	dynamic C _r newtons	static C _{0r} newtons		
88.5	58.5	32.0	76.0	22.5	36.0	27.5	13.50	29.0	38.0	14000	7880	6250	1.0
101.5	64.5	37.5	89.0	22.5	36.5	30.0	13.50	31.0	45.0	19500	11300	5300	1.6
101.5	64.5	37.5	89.0	22.5	36.5	30.0	13.50	35.0	52.0	25700	15300	4500	1.6
118.0	82.5	49.5	101.0	29.0	49.5	37.0	17.50	36.0	58.0	32500	19900	4000	2.7
118.0	82.5	49.5	101.0	29.0	49.5	37.0	17.50	39.0	65.0	32500	20500	3700	2.8
118.0	82.5	49.5	101.0	29.0	49.5	37.0	17.50	42.0	70.0	35000	23200	3400	2.8
146.0	101.0	64.0	130.0	35.0	63.5	46.5	27.00	45.0	75.0	43500	29200	3100	4.2

Self-Lube® cast iron conveyor belt tensioner units

BT Series

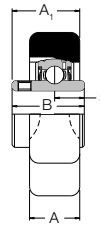
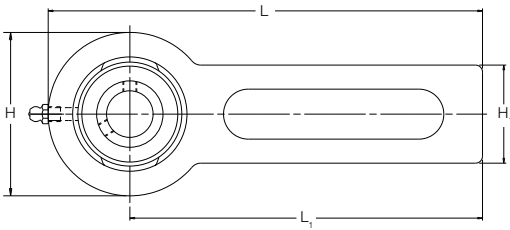

BT

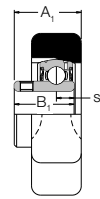

BT-A

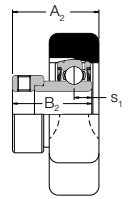

BT-EC

Shaft diameter mm inches	RHP designation			Basic bearing insert	Casting group	Dimensions (mm)			
	H	H ₁	L			L ₁			
25 7/8 1 1/16 1	BT25 BT7/8 BT1 5/16 BT1	BT25A BT1A	BT25EC BT7/8EC BT1 5/16EC BT1EC	1025	3	78.0	42.5	264.0	225.0
30	BT30L			1035	5	98.0	42.5	274.0	225.0
35 1 3/16 1 1/4 1 3/8 1 7/16	BT35 BT1 3/16L BT1 1/4 BT1 3/8 BT1 7/16	BT35A BT1 1/4A	BT35EC BT1 1/4EC BT1 3/8EC BT1 7/16EC						

Please check availability

Bearing inserts with flinger seals shown on pages 89 and 90 can be fitted into these housings. The unit reference has the suffix 'FS', e.g. BT35FS.

Triple seal bearing inserts shown on pages 86 to 88 can be fitted into these housings. The unit reference has a prefix 'T', e.g. TBT35.

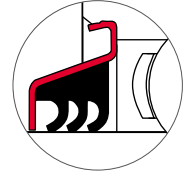
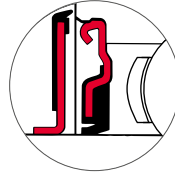

Dimensions (mm)								ISO Load ratings		Rec. max. speed rev/min	Mass (approx.) kg
A	A ₁	A ₂	B	B ₁	B ₂	s	s ₁	dynamic C newtons	static C ₀ newtons		
22.0	30.57	34.20	34.10	27.30	31.03	14.33	7.53	14000	7880	6250	1.8
22.0	36.13	40.20	42.90	34.90	38.93	17.53	9.53	25700	15300	4500	2.3

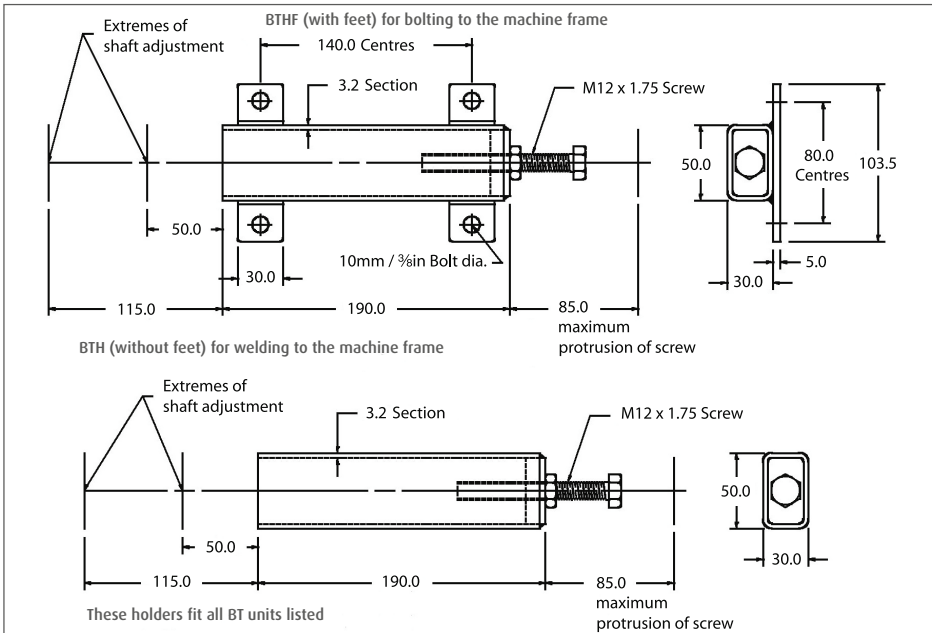

Self-Lube® cast iron cartridge bearing units

SLC Series

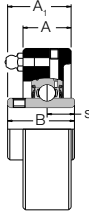
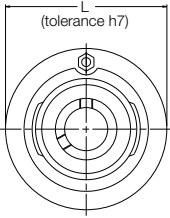

For housing tolerances to suit outside dia 'L' see page 19

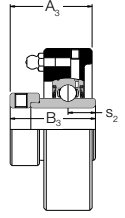
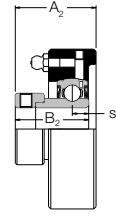
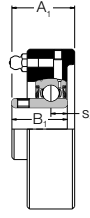

SLC

SLC-A

SLC-EC

SLC-DEC

Shaft diameter		RHP designation				Basic bearing insert	Casting group	Dimensions (mm)			
mm	inches							L	A	A ₁	A ₂
12		SLC12		SLC12EC		1017	1	68.287	22.22	24.21	30.35
15		SLC15		SLC15EC							
16		SLC16		SLC16EC							
17		SLC17		SLC17EC							
	1/2	SLC1 1/2		SLC1 1/2EC							
	5/8	SLC5/8		SLC5/8EC							
20		SLC20	SLC20A	SLC20EC	SLC20DEC	1020	2	74.367	22.22	29.39	34.54
	3/4	SLC3/4	SLC3/4A	SLC3/4EC	SLC3/4DEC						
25		SLC25	SLC25A	SLC25EC	SLC25DEC	1025	3	79.400	26.19	32.94	36.52
	7/8	SLC7/8		SLC7/8EC	SLC7/8DEC						
	15/16	SLC15/16		SLC15/16EC	SLC15/16DEC						
	1	SLC1	SLC1A	SLC1EC	SLC1DEC						
30		SLC30	SLC30A	SLC30EC	SLC30DEC	1030	4	88.925	27.78	36.12	40.56
	1 1/8	SLC1 1/8		SLC1 1/8EC	SLC1 1/8DEC						
	1 1/16	SLC1 1/16		SLC1 1/16EC	SLC1 1/16DEC						
	1 1/4	SLC1 1/4R	SLC1 1/4AR	SLC1 1/4ECR	SLC1 1/4DEC						
35		SLC35	SLC35A	SLC35EC	SLC35DEC	1035	5	98.450	30.96	40.87	44.81
	1 1/4	SLC1 1/4	SLC1 1/4A	SLC1 1/4EC	SLC1 1/4DEC						
	1 3/8	SLC1 3/8		SLC1 3/8EC	SLC1 3/8DEC						
	1 7/16	SLC1 7/16		SLC1 7/16EC	SLC1 7/16DEC						
40		SLC40	SLC40A	SLC40EC	SLC40DEC	1040	6	106.387	37.31	48.84	51.28
	1 1/2	SLC1 1/2	SLC1 1/2A	SLC1 1/2EC	SLC1 1/2DEC						
45		SLC45	SLC45A	SLC45EC	SLC45DEC	1045	7	111.150	36.51	48.44	50.88
	1 5/8	SLC1 5/8		SLC1 5/8EC	SLC1 5/8DEC						
	1 11/16	SLC1 11/16		SLC1 11/16EC	SLC1 11/16DEC						
	1 3/4	SLC1 3/4	SLC1 3/4A	SLC1 3/4EC	SLC1 3/4DEC						
50		SLC50	SLC50A	SLC50EC	SLC50DEC	1050	8	115.913	37.31	51.18	51.28
	1 7/8	SLC1 7/8		SLC1 7/8EC	SLC1 7/8DEC						
	1 15/16	SLC1 15/16		SLC1 15/16EC	SLC1 15/16DEC						
	2	SLC2R									
55		SLC55			SLC55DEC	1055	9	125.437	40.48	53.57	-
	2	SLC2			SLC2DEC						
	2 1/8	SLC2 1/8			SLC2 1/8DEC						
	2 1/16	SLC2 1/16			SLC2 1/16DEC						
60		SLC60			SLC60DEC	1060	10	149.250	41.28	60.30	-
	2 1/4	SLC2 1/4			SLC2 1/4DEC						
	2 3/8	SLC2 3/8			SLC2 3/8DEC						
	2 7/16	SLC2 7/16			SLC2 7/16DEC						
65		SLC65				1065	10/65	149.250	41.28	60.30	-
	2 1/2	SLC2 1/2			SLC2 1/2DEC						

Please check availability

Bearing inserts with flinger seals shown on pages 89 and 90 can be fitted into these housings. The unit reference has the suffix 'FS', e.g. SLC25FS.

Triple seal bearing inserts shown on pages 86 to 88 can be fitted into these housings. The unit reference has a prefix 'T', e.g. TSLC25.

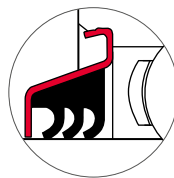
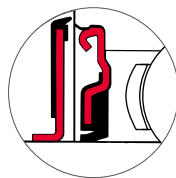

Dimensions (mm)								ISO Load ratings		Rec. max. speed	Mass (approx.)
A ₃	B	B ₁	B ₂	B ₃	s	s ₁	s ₂	dynamic C _r newtons	static C _{0r} newtons	rev/min	kg
-	27.38	-	28.63	-	11.58	6.53	-	9550	4800	7000	0.6
37.67	31.00	25.80	31.03	43.73	12.73	7.53	17.13	12800	6650	6700	0.7
40.06	34.10	27.30	31.03	44.43	14.33	7.53	17.53	14000	7880	6250	0.8
43.99	38.10	31.20	35.73	48.43	15.93	9.03	18.33	19500	11300	5300	1.1
47.78	42.90	34.90	38.93	51.13	17.53	9.53	18.83	25700	15300	4500	1.4
53.57	49.20	41.20	43.73	56.33	19.03	11.03	21.43	32500	19900	4000	2.0
53.16	49.20	41.20	43.73	56.33	19.04	11.04	21.43	32500	20500	3700	2.1
56.72	51.60	43.50	43.73	62.73	19.04	11.04	24.64	35000	23200	3400	2.3
63.83	55.60	-	-	71.42	22.24	-	27.82	43500	29200	3100	2.9
67.39	65.10	-	-	77.84	25.44	-	31.04	48000	33000	2800	4.4
67.39	65.10	-	-	85.74	25.44	-	34.14	57500	40000	2600	4.5

Self-Lube[®] cast iron cartridge bearing units

MSC Series

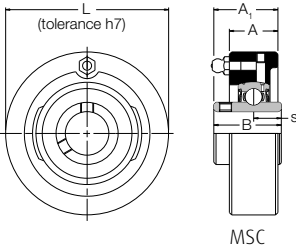

For housing tolerances
to suit outside dia 'L' see
page 19

Shaft diameter		RHP designation	Basic bearing insert	Casting group	Dimensions (mm)	
mm	inches				L	A
25		MSC25	1030	1	88.925	27.78
30		**				
	1	MSC1				
		**				
35		MSC1	1035	2	98.450	30.96
	1 ³ / ₁₆	MSC1 ³ / ₁₆				
	1 ¹ / ₄	**				
40		**	1040	3	106.387	37.31
	1 ³ / ₈	MSC1 ³ / ₈				
	1 ⁷ / ₁₆	MSC1 ⁷ / ₁₆				
45		**	1045	4	111.150	36.51
	1 ¹ / ₂	MSC1 ¹ / ₂				
50		**	1050	5	115.913	37.31
	1 ¹¹ / ₁₆	MSC1 ¹¹ / ₁₆				
	1 ³ / ₄	MSC1 ³ / ₄				
55		**	1055	6	125.437	40.48
	1 ⁷ / ₈	MSC1 ⁷ / ₈				
	1 ¹⁵ / ₁₆	MSC1 ¹⁵ / ₁₆				
	2	**				
60		**	1060	7	149.250	41.28
	2 ³ / ₁₆	MSC2 ³ / ₁₆				
	2 ¹ / ₄	**				
65		MSC65	1070	8	158.775	50.80
70		MSC70				
	2 ⁷ / ₁₆	MSC2 ⁷ / ₁₆				
	2 ¹ / ₂	MSC2 ¹ / ₂				
75		MSC75	1075	9	168.300	50.80
	2 ¹¹ / ₁₆	MSC2 ¹¹ / ₁₆				
	2 ³ / ₄	MSC2 ³ / ₄				
80		MSC80	1080	10	177.825	55.56
	2 ¹⁵ / ₁₆	MSC2 ¹⁵ / ₁₆				
	3	MSC3				
85		MSC85	1085	11	188.937	63.50
	3 ¹ / ₁₆	MSC3 ¹ / ₁₆				
	3 ¹ / ₄	MSC3 ¹ / ₄				
90		MSC90	1090	12	207.987	63.50
	3 ⁷ / ₁₆	MSC3 ⁷ / ₁₆				
	3 ¹ / ₂	MSC3 ¹ / ₂				
95		MSC95	3095	13	241.325	76.20
100		MSC100				
	3 ¹⁵ / ₁₆	MSC3 ¹⁵ / ₁₆				
	4	MSC4				

Please check availability

** For these bore sizes select from SLC Series (see page 62)

Bearing inserts with flinger seals shown on pages 89 and 90 can be fitted into these housings. The unit reference has the suffix 'FS', e.g. MSC 1 3/16 FS.

Triple seal bearing inserts shown on pages 86 to 88 can be fitted into these housings. The unit reference has a prefix 'T', e.g. TMSC 1 3/16.

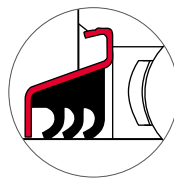
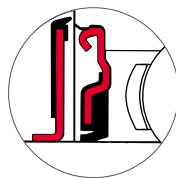

A ₁	B	s	ISO Load ratings		Rec. max. speed rev/min	Mass (approx.) kg
			dynamic C _r newtons	static C _{0r} newtons		
36.12	38.10	15.93	19500	11300	5300	1.1
40.87	42.90	17.53	25700	15300	4500	1.4
48.84	49.20	19.03	32500	19900	4000	2.0
48.44	49.20	19.04	32500	20500	3700	2.1
51.18	51.60	19.04	35000	23200	3400	2.3
53.57	55.60	22.24	43500	29200	3100	2.9
60.30	65.10	25.44	48000	33000	2800	4.4
69.80	74.60	30.24	61000	45000	2450	5.3
69.80	77.80	33.34	66000	49500	2300	6.2
76.99	82.60	33.34	71500	54500	2150	7.9
83.29	85.70	34.15	83000	64000	2000	9.3
88.06	96.00	39.74	96000	71500	1900	12.7
106.38	117.48	49.31	157000	122000	1600	20.4

Self-Lube® cast iron hanger bearing units

SCHB Series (BSP thread), SCH Series (metric thread)**

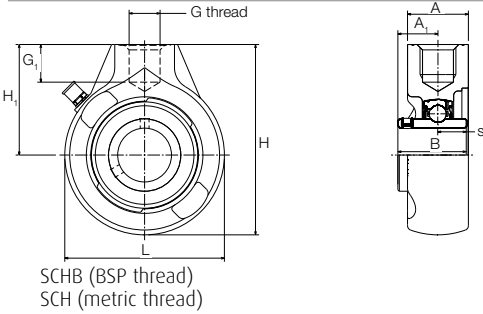

Shaft diameter		RHP designation		Basic bearing insert	Casting group	Dimensions (mm)			
mm	inches					G (BSP)	G (metric)	G ₁ (mm)	L
20		SCHB20	SCH20	1020	0	½	M16 x 2.00	19.0	67.0
	¾	SCHB¾	SCH¾						
25		SCHB25	SCH25	1030	2/0	½	M20 x 2.50	16.0	89.0
30		SCHB30	SCH30						
	7/8	SCHB7/8	SCH7/8						
	1	SCHB1	SCH1						
	1 1/8	SCHB1 1/8	SCH1 1/8						
35		SCHB35	SCH35	1035	1	¾	M24 x 3.00	19.0	97.0
	1 3/16	SCHB1 3/16	SCH1 3/16						
	1 ¼	SCHB1 ¼	SCH1 ¼						
	1 ½	SCHB1 ½	SCH1 ½						
40		SCHB40	SCH40	1040	2	¾	M24 x 3.00	19.0	107.0
	1 7/16	SCHB1 7/16	SCH1 7/16						
	1 ½	SCHB1 ½	SCH1 ½						
45		SCHB45	SCH45	1050	3	1	M24 x 3.00	21.0	121.0
50		SCHB50	SCH50						
	1 11/16	SCHB1 11/16	SCH1 11/16						
	1 ¾	SCHB1 ¾	SCH1 ¾						
	1 7/8	SCHB1 7/8	SCH1 7/8						
	1 5/8	SCHB1 5/8	SCH1 5/8						
	2	SCHB2	SCH2						
55		SCHB55	SCH55	1060	4	1 ¼	M42 x 4.50	29.0	146.5
60		SCHB60	SCH60						
	2 3/16	SCHB2 3/16	SCH2 3/16						
	2 ¼	SCHB2 ¼	SCH2 ¼						
	2 ½	SCHB2 ½	SCH2 ½						
	2 7/16	SCHB2 7/16	SCH2 7/16						
	2 ½	SCHB2 ½	SCH2 ½	1065	4/65	1 ¼	M42 x 4.50	29.0	143.0
65		SCHB65	SCH65	1075	5	1 ½	M48 x 5.00	32.0	165.0
70		SCHB70	SCH70						
75		SCHB75	SCH75						
	2 11/16	SCHB2 11/16	SCH2 11/16						
	2 ¾	SCHB2 ¾	SCH2 ¾						
	2 7/8	SCHB2 7/8	SCH2 7/8						
	2 5/8	SCHB2 5/8	SCH2 5/8						
80		SCHB80	SCH80	1080	6	1 ½	M48 x 5.00	32.0	174.5
	3	SCHB3	SCH3						
	3 3/16	SCHB3 3/16	SCH3 3/16						

Please check availability

**These series units are identical to SCHB series except for thread details

Bearing inserts with flinger seals shown on pages 89 and 90 can be fitted into these housings. The unit reference has the suffix 'FS', e.g. SCHB35FS.

Triple seal bearing inserts shown on pages 86 to 88 can be fitted into these housings. The unit reference has a prefix 'T', e.g. TSCHB35.

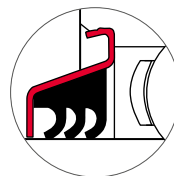
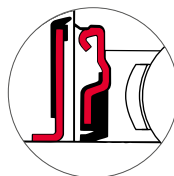

Dimensions (mm)						ISO Load ratings		Rec. max. speed rev/min	Mass (approx.) kg
H	H ₁	A	A ₁	B	s	dynamic C _r newtons	static C _{0r} newtons		
91.6	57.2	34.0	18.26	30.96	12.73	12800	6650	6700	0.8
107.5	61.9	33.5	22.22	38.10	15.93	19500	11300	5300	1.2
119.0	69.8	39.5	25.40	42.88	17.53	25700	15300	4500	1.5
127.5	73.0	39.5	27.79	49.23	19.03	32500	19900	4000	1.6
144.0	82.6	47.5	27.79	51.59	19.03	35000	23200	3400	2.2
175.0	101.6	58.5	30.94	65.07	25.44	48000	33000	2800	3.5
173.5	101.6	58.5	30.94	65.07	25.44	57500	40000	2600	3.4
200.6	117.5	70.0	34.94	77.77	33.34	66000	49500	2300	6.8
211.5	123.8	71.5	41.29	82.55	33.34	71500	54500	2150	8.1

Self-Lube® pressed steel flange bearing units (zinc plated housings)

SLFE Series**

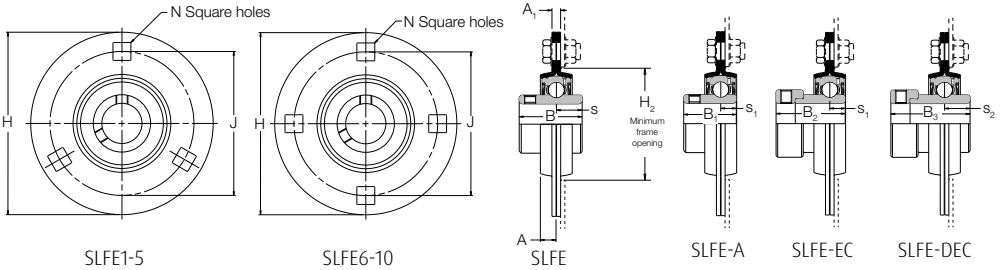

Shaft diameter		RHP designation				Basic bearing insert	Casting group	Dimensions (mm)			
mm	inches							H	H ₂	J	N
12		SLFE12		SLFE12EC		1017	1	81.0	49.0	63.5	7.1
15		SLFE15		SLFE15EC							
16		SLFE16		SLFE16EC							
17		SLFE17		SLFE17EC							
	1/2	SLFE1/2		SLFE1/2EC							
	5/8	SLFE5/8		SLFE5/8EC							
20		SLFE20	SLFE20A	SLFE20EC	SLFE20DEC	1020	2	90.5	55.0	71.4	8.7
	3/4	SLFE3/4	SLFE3/4A	SLFE3/4EC	SLFE3/4DEC						
25		SLFE25	SLFE25A	SLFE25EC	SLFE25DEC	1025	3	95.2	60.0	76.0	8.7
	7/8	SLFE7/8		SLFE7/8EC	SLFE7/8DEC						
	15/16	SLFE15/16		SLFE15/16EC	SLFE15/16DEC						
	1	SLFE1	SLFE1A	SLFE1EC	SLFE1DEC						
30		SLFE30	SLFE30A	SLFE30EC	SLFE30DEC	1030	4	112.7	71.0	90.5	10.5
	1 1/8	SLFE1 1/8		SLFE1 1/8EC	SLFE1 1/8DEC						
	1 3/16	SLFE1 3/16		SLFE1 3/16EC	SLFE1 3/16DEC						
	1 1/4	SLFE1 1/4	SLFE1 1/4A	SLFE1 1/4EC	SLFE1 1/4DEC						
35	1 1/4	SLFE35	SLFE35A	SLFE35EC	SLFE35DEC	1035	5	122.2	81.0	100.0	10.5
	35	SLFE1 1/4L	SLFE1 1/4AL	SLFE1 1/4ECL	SLFE1 1/4DECL						
	1 3/8	SLFE1 3/8		SLFE1 3/8EC	SLFE1 3/8DEC						
	1 7/16	SLFE1 7/16		SLFE1 7/16EC	SLFE1 7/16DEC						
40		SLFE40	SLFE40A	SLFE40EC	SLFE40DEC	1040	6	147.8	91.0	119.0	13.5
	1 1/2	SLFE1 1/2	SLFE1 1/2A	SLFE1 1/2EC	SLFE1 1/2DEC						
45		SLFE45	SLFE45A	SLFE45EC	SLFE45DEC	1045	7	149.2	97.0	120.5	13.5
	1 5/8	SLFE1 5/8		SLFE1 5/8EC	SLFE1 5/8DEC						
	1 11/16	SLFE1 11/16		SLFE1 11/16EC	SLFE1 11/16DEC						
	1 3/4	SLFE1 3/4	SLFE1 3/4A	SLFE1 3/4EC	SLFE1 3/4DEC						
50		SLFE50	SLFE50A	SLFE50EC	SLFE50DEC	1050	8	155.6	102.0	127.0	13.5
	1 7/8	SLFE1 7/8		SLFE1 7/8EC	SLFE1 7/8DEC						
	1 15/16	SLFE1 15/16		SLFE1 15/16EC	SLFE1 15/16DEC						
	2	SLFE2R									
55		SLFE55		SLFE55DEC		1055	9	166.6	113.0	138.0	13.5
	2	SLFE2		SLFE2DEC							
	2 1/8	SLFE2 1/8		SLFE2 1/8DEC							
	2 3/16	SLFE2 3/16		SLFE2 3/16DEC							
60		SLFE60		SLFE60DEC		1060	10	176.2	122.0	147.6	13.5
	2 1/4	SLFE2 1/4		SLFE2 1/4DEC							
	2 7/16	SLFE2 7/16		SLFE2 7/16DEC							

Please check availability

A modified version of these units is available if a Protector is to be fitted, see page 91 for details

**Housings of groups 6 to 10 inclusive have four bolt holes. Note: These units are not re-greaseable

Bearing inserts with flinger seals shown on pages 89 and 90 can be fitted into these housings. The unit reference has the suffix 'FS', e.g. SLFE25FS.

Triple seal bearing inserts shown on pages 86 to 88 can be fitted into these housings. The unit reference has a prefix 'T', e.g. TSLFE25.

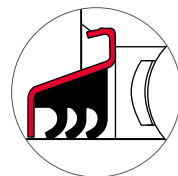
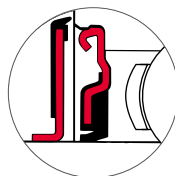

Dimensions (mm)									Max. radial housing load	Rec. max. speed	Mass (approx.)
A	A ₁	B	B ₁	B ₂	B ₃	s	s ₁	s ₂	newtons	rev/min	kg
6.7	4.0	27.38	-	28.63	-	11.58	6.53	-	2670	3000	0.2
7.7	4.0	31.00	25.80	31.03	43.73	12.73	7.53	17.13	3110	3000	0.3
8.7	4.0	34.10	27.30	31.03	44.43	14.33	7.53	17.53	3560	2500	0.4
9.0	5.0	38.10	31.20	35.73	48.43	15.93	9.03	18.33	4890	2500	0.7
10.0	5.0	42.90	34.90	38.93	51.13	17.53	9.53	18.83	6250	2000	0.9
10.0	7.0	49.20	41.20	43.73	56.33	19.03	11.03	21.43	7550	2000	1.5
10.0	7.0	49.20	41.20	43.73	56.33	19.04	11.04	21.43	7550	2000	1.6
10.5	8.0	51.60	43.50	43.73	62.73	19.04	11.04	24.64	8450	1500	1.8
10.7	8.0	55.60	-	-	71.42	22.24	-	27.84	10200	1500	2.2
11.9	8.0	65.10	-	-	77.84	25.44	-	31.04	11300	1500	2.5

Self-Lube® pressed steel flange bearing units (zinc plated housings)

SLFT Series**

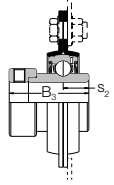
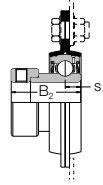
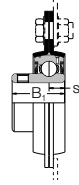
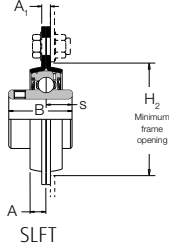
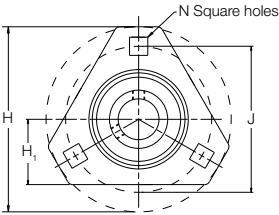

SLFT

SLFT-A

SLFT-EC

SLFT-DEC

Shaft diameter		RHP designation				Basic bearing insert	Casting group	Dimensions (mm)				
mm	inches							H	H ₁	H ₂	J	N
25		SLFT25	SLFT25A	SLFT25EC	SLFT25DEC	1025	3	95.2	34.2	60.0	76.0	8.7
	7/8	SLFT7/8		SLFT7/8EC	SLFT7/8DEC							
	1 1/16	SLFT1 1/16		SLFT1 1/16EC	SLFT1 1/16DEC							
	1	SLFT1	SLFT1A	SLFT1EC	SLFT1DEC							
30		SLFT30	SLFT30A	SLFT30EC	SLFT30DEC	1030	4	112.7	40.2	71.0	90.5	10.5
	1 1/8	SLFT1 1/8		SLFT1 1/8EC	SLFT1 1/8DEC							
	1 3/16	SLFT1 3/16		SLFT1 3/16EC	SLFT1 3/16DEC							
	1 1/4	SLFT1 1/4	SLFT1 1/4A	SLFT1 1/4EC	SLFT1 1/4DEC							
35		SLFT35	SLFT35A	SLFT35EC	SLFT35DEC	1035	5	122.2	44.2	81.0	100.0	10.5
	1 1/4	SLFT1 1/4L	SLFT1 1/4AL	SLFT1 1/4ECL	SLFT1 1/4DECL							
	1 3/8	SLFT1 3/8		SLFT1 3/8EC	SLFT1 3/8DEC							
	1 1/16	SLFT1 1/16		SLFT1 1/16EC	SLFT1 1/16DEC							

Please check availability

A modified version of these units is available if a Protector is to be fitted, see page 91 for details

**Note: These units are not re-greaseable

Bearing inserts with flinger seals shown on pages 89 and 90 can be fitted into these housings. The unit reference has the suffix 'FS', e.g. SLFT25FS.

Triple seal bearing inserts shown on pages 86 to 88 can be fitted into these housings. The unit reference has a prefix 'T', e.g. TSLFT25.

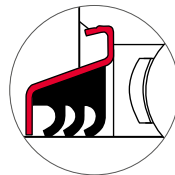
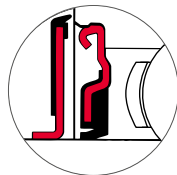

Dimensions (mm)									Max. radial housing load	Rec. max. speed	Mass (approx.)
A	A ₁	B	B ₁	B ₂	B ₃	s	s ₁	s ₂	newtons	rev/min	kg
8.7	4.0	34.10	27.30	31.03	44.43	14.33	7.53	17.53	3560	2500	0.3
9.0	5.0	38.10	31.20	35.73	48.43	15.93	9.03	18.33	4890	2500	0.5
10.0	5.0	42.90	34.90	38.93	51.13	17.53	9.53	18.83	6250	2000	0.7

Self-Lube® pressed steel flange bearing units (zinc plated housings)

SLFL Series**

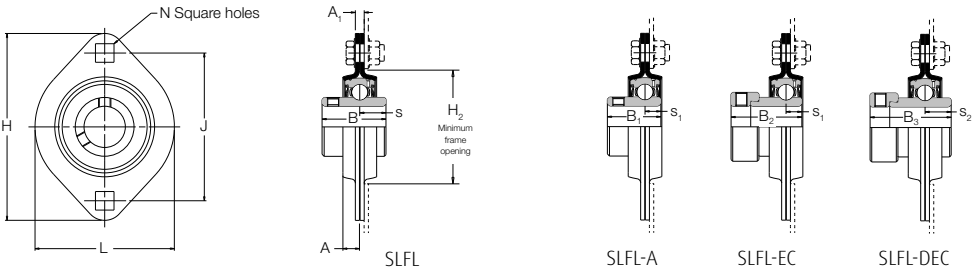

Shaft diameter		RHP designation				Basic bearing insert	Casting group	Dimensions (mm)				
mm	inches							L	H	H ₂	J	N
12		SLFL12		SLFL12EC		1017	1	58.7	81.0	49.0	63.5	7.1
15		SLFL15		SLFL15EC								
16		SLFL16		SLFL16EC								
17		SLFL17		SLFL17EC								
	1/2	SLFL1/2		SLFL1/2EC								
	3/8	SLFL3/8		SLFL3/8EC								
20		SLFL20	SLFL20A	SLFL20EC	SLFL20DEC	1020	2	66.7	90.5	55.0	71.5	8.7
	3/4	SLFL3/4	SLFL3/4A	SLFL3/4EC	SLFL3/4DEC							
25		SLFL25	SLFL25A	SLFL25EC	SLFL25DEC	1025	3	71.0	95.3	60.0	76.0	8.7
	7/8	SLFL7/8		SLFL7/8EC	SLFL7/8DEC							
	15/16	SLFL15/16		SLFL15/16EC	SLFL15/16DEC							
	1	SLFL1	SLFL1A	SLFL1EC	SLFL1DEC							
30		SLFL30	SLFL30A	SLFL30EC	SLFL30DEC	1030	4	84.1	112.7	71.0	90.5	10.5
	1 1/8	SLFL1 1/8		SLFL1 1/8EC	SLFL1 1/8DEC							
	1 3/16	SLFL1 3/16		SLFL1 3/16EC	SLFL1 3/16DEC							
	1 1/4	SLFL1 1/4	SLFL1 1/4A	SLFL1 1/4EC	SLFL1 1/4DEC							
35		SLFL35	SLFL35A	SLFL35EC	SLFL35DEC	1035	5	93.6	122.6	81.0	100.0	10.8
	1 1/4 L	SLFL1 1/4	SLFL1 1/4AL	SLFL1 1/4ECL	SLFL1 1/4DECL							
	1 3/8	SLFL1 3/8	SLFL1 3/8A	SLFL1 3/8EC	SLFL1 3/8DEC							
	1 7/16	SLFL1 7/16	SLFL1 7/16A	SLFL1 7/16EC	SLFL1 7/16DEC							

Please check availability

A modified version of these units is available if a Protector is to be fitted, see page 91 for details

**Note: These units are not re-greaseable

Bearing inserts with flinger seals shown on pages 89 and 90 can be fitted into these housings. The unit reference has the suffix 'FS', e.g. SLFL1FS.

Triple seal bearing inserts shown on pages 86 to 88 can be fitted into these housings. The unit reference has a prefix 'T', e.g. TSLFL1.

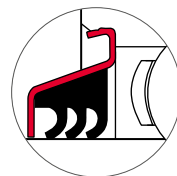
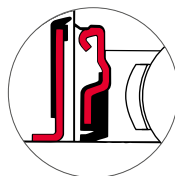

Dimensions (mm)									Max. radial housing load newtons	Rec. max. speed rev/min	Mass (approx.) kg
A	A ₁	B	B ₁	B ₂	B ₃	s	s ₁	s ₂			
6.7	4.0	27.38	-	28.63	-	11.58	6.53	-	2670	3000	0.2
7.7	4.0	31.00	25.80	31.03	43.73	12.73	7.53	17.13	3110	3000	0.3
8.7	4.0	34.10	27.30	31.03	44.43	14.33	7.53	17.53	3560	2500	0.3
9.0	5.0	38.10	31.20	35.73	48.43	15.93	9.03	18.33	4890	2500	0.5
10.0	5.0	42.9	34.90	38.96	51.13	17.53	9.53	18.83	6250	2000	0.7

Self-Lube® pressed steel pillow block units (zinc plated housings)

LPB Series**

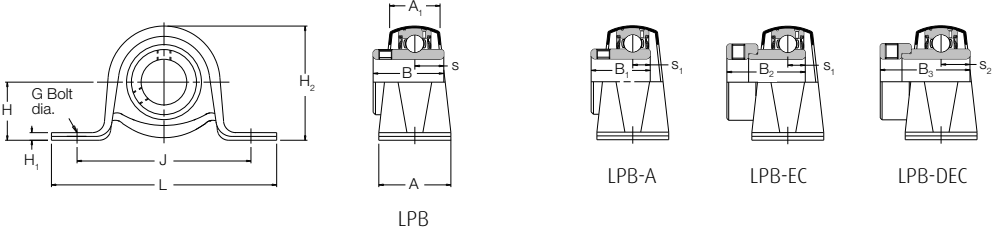

Shaft diameter		RHP designation				Basic bearing insert	Casting group	Dimensions (mm)				
mm	inches							L	H	H ₁	H ₂	J
12		LPB12		LPB12EC		1017	1	85.7	22.2	2.4	43.2	68.0
15		LPB15		LPB15EC								
16		LPB16		LPB16EC								
17		LPB17		LPB17EC								
	1/2	LPB1/2		LPB1/2EC								
	3/8	LPB3/8		LPB3/8EC								
20		LPB20	LPB20A	LPB20EC	LPB20DEC	1020	2	98.4	25.4	2.4	49.9	76.0
	3/4	LPB3/4	LPB3/4A	LPB3/4EC	LPB3/4DEC							
25		LPB25	LPB25A	LPB25EC	LPB25DEC	1025	3	108.0	28.6	2.8	55.8	86.0
	7/8	LPB7/8		LPB7/8EC	LPB7/8DEC							
	15/16	LPB15/16		LPB15/16EC	LPB15/16DEC							
	1	LPB1	LPB1A	LPB1EC	LPB1DEC							
30		LPB30	LPB30A	LPB30EC	LPB30DEC	1030	4	117.5	33.3	3.6	65.7	95.0
	1 1/8	LPB1 1/8		LPB1 1/8EC	LPB1 1/8DEC							
	1 3/16	LPB1 3/16		LPB1 3/16EC	LPB1 3/16DEC							
	1 1/4	LPB1 1/4	LPB1 1/4A	LPB1 1/4EC	LPB1 1/4DEC							
35		LPB35	LPB35A	LPB35EC	LPB35DEC	1035	5	128.6	39.7	4.4	77.5	106.0
	1 1/4	LPB1 1/4L	LPB1 1/4AL	LPB1 1/4ECL	LPB1 1/4DECL							
	1 3/8	LPB1 3/8		LPB1 3/8EC	LPB1 3/8DEC							
	1 7/16	LPB1 7/16		LPB1 7/16EC	LPB1 7/16DEC							

Please check availability

**Note: These units are not re-greaseable

Dimensions (mm)										Max. radial housing load newtons	Rec. max. speed rev/min	Mass (approx.) kg
G	A	A ₁	B	B ₁	B ₂	B ₃	s	s ₁	s ₂			
8	25.4	15.9	27.38	-	28.63	-	11.58	6.53	-	1330	3000	0.2
8	31.7	21.6	31.00	25.80	31.03	43.73	12.73	7.53	17.13	1570	3000	0.2
10	31.7	21.6	34.10	27.30	31.03	44.43	14.33	7.53	17.53	1780	2500	0.3
10	37.5	25.5	38.10	31.20	35.73	48.43	15.93	9.03	18.33	2670	2500	0.5
10	41.0	28.4	42.90	34.90	38.93	51.13	17.53	9.53	18.89	3560	2000	0.9

Self-Lube® pressed steel rubber mounted pillow block units (zinc plated housings)

LPBR Series**

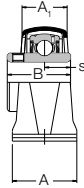
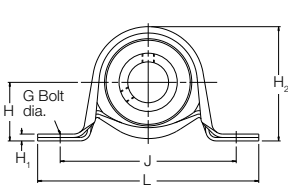

LPBR

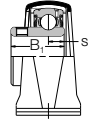

LPBR-A

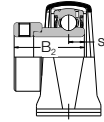

LPBR-EC

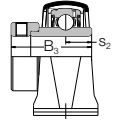

LPBR-DEC

Shaft diameter		RHP designation				Basic bearing insert	Casting group	Dimensions (mm)				
mm	inches							L	H	H ₁	H ₂	J
12		LPBR12		LPBR12EC		1017	2	98.4	25.4	2.4	49.9	76.0
15		LPBR15		LPBR15EC								
16		LPBR16		LPBR16EC								
17		LPBR17		LPBR17EC								
	1/2	LPBR1/2		LPBR1/2EC								
	3/8	LPBR3/8		LPBR3/8EC								
20		LPBR20	LPBR20A	LPBR20EC	LPBR20DEC	1020	3	108.0	28.6	2.8	55.8	86.0
	3/4	LPBR3/4	LPBR3/4A	LPBR3/4EC	LPBR3/4DEC							
25		LPBR25	LPBR25A	LPBR25EC	LPBR25DEC	1025	4	117.5	33.3	3.6	65.7	95.0
	7/8	LPBR7/8		LPBR7/8EC	LPBR7/8DEC							
	15/16	LPBR15/16		LPBR15/16EC	LPBR15/16DEC							
	1	LPBR1	LPBR1A	LPBR1EC	LPBR1DEC							
30		LPBR30	LPBR30A	LPBR30EC	LPBR30DEC	1030	5	128.6	39.7	4.4	77.5	106.0
	1 1/8	LPBR1 1/8		LPBR1 1/8EC	LPBR1 1/8DEC							
	1 3/16	LPBR1 3/16		LPBR1 3/16EC	LPBR1 3/16DEC							
	1 1/4	LPBR1 1/4	LPBR1 1/4A	LPBR1 1/4EC	LPBR1 1/4DEC							

Please check availability

**Note: These units are not re-greaseable

G	Dimensions (mm)									Max. radial housing load newtons	Rec. max. speed rev/min	Mass (approx.) kg
	A	A₁	B	B₁	B₂	B₃	s	s₁	s₂			
8	31.7	21.6	27.38	-	28.63	-	11.58	6.53	-	890	3000	0.2
10	31.7	21.6	31.00	25.80	31.03	43.73	12.73	7.53	17.13	1110	3000	0.3
10	37.5	25.5	34.10	27.30	31.03	44.43	14.33	7.53	17.53	1330	2500	0.5
10	41.0	28.4	38.10	31.20	35.73	48.43	15.93	9.03	18.33	1560	2500	0.9

Self-Lube® bearing inserts

1000G and 1100 Series

1000G

With spherical outside diameter and integral set screw lock

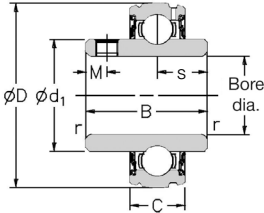

1100

With parallel outside diameter and integral set screw lock

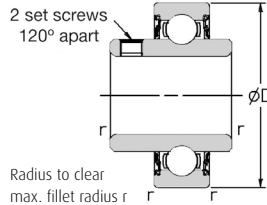

Shaft diameter mm inches	RHP designation		Dimensions (mm)						ISO Load ratings		Rec. max. speed rev/min	Mass (approx.) kg	
	1000G Series	1100 Series	D	C	B	s	d ₁	M	r	dynamic C _r newtons			static C _{0r} newtons
12		1017-12G 1117-12	40.000	12.00	27.38	11.58	24.80	5.00	0.60	9550	4800	7000	0.09
15		1017-15G 1117-15											
16		1017-16G 1117-16											
17		1017-17G 1117-17											
1/2		1017-1/2G 1117-1/2											
3/8		1017-3/8G 1117-3/8											
20		1020-20G 1120-20	47.000	14.00	31.00	12.73	28.30	5.00	1.00	12800	6650	6700	0.13
	3/4	1020-3/4G 1120-3/4											
25		1025-25G 1125-25	52.000	15.00	34.10	14.33	34.00	5.00	1.00	14000	7880	6250	0.17
	7/8	1025-7/8G 1125-7/8											
	15/16	1025-15/16G 1125-15/16											
	1	1025-1G 1125-1											
25		1030-25G 1130-25	62.000	16.00	38.10	15.93	40.30	5.00	1.00	19500	11300	5300	0.37
30		1030-30G 1130-30											
	1	1030-1G 1130-1											
	1 1/8	1030-1 1/8G 1130-1 1/8											
	1 1/16	1030-1 1/16G 1130-1 1/16											
	1 1/4	1030-1 1/4G 1130-1 1/4											
30		1035-30G 1135-30	72.000	17.00	42.90	17.53	46.90	6.50	1.00	25700	15300	4500	0.51
35		1035-35G 1135-35											
	1 3/16	1035-1 3/16G 1135-1 3/16											
	1 1/4	1035-1 1/4G 1135-1 1/4											
	1 5/16	1035-1 5/16G 1135-1 5/16											
	1 3/8	1035-1 3/8G 1135-1 3/8											
	1 1/2	1035-1 1/2G 1135-1 1/2											
35		1040-35G 1140-35	80.000	18.00	49.20	19.03	52.40	8.00	1.00	32500	19900	4000	0.64
40		1040-40G 1140-40											
	1 3/8	1040-1 3/8G 1140-1 3/8											
	1 7/16	1040-1 7/16G 1140-1 7/16											
	1 1/2	1040-1 1/2G 1140-1 1/2											
40		1045-40G 1145-40	85.000	19.00	49.20	19.04	57.40	8.00	1.00	32500	20500	3700	0.73
45		1045-45G 1145-45											
	1 1/2	1045-1 1/2G 1145-1 1/2											
	1 5/8	1045-1 5/8G 1145-1 5/8											
	1 11/16	1045-1 11/16G 1145-1 11/16											
	1 3/4	1045-1 3/4G 1145-1 3/4											
45		1050-45G 1150-45	90.000	20.00	51.60	19.04	62.40	10.00	1.00	35000	23200	3400	0.91
50		1050-50G 1150-50											
	1 11/16	1050-1 11/16G 1150-1 11/16											
	1 3/4	1050-1 3/4G 1150-1 3/4											
	1 7/8	1050-1 7/8G 1150-1 7/8											
	1 15/16	1050-1 15/16G 1150-1 15/16											
	2	1050-2G 1150-2											
50		1055-50G 1155-50	100.000	21.00	55.60	22.24	68.90	10.00	1.50	43500	29200	3100	1.12
55		1055-55G 1155-55											
	1 7/8	1055-1 7/8G 1155-1 7/8											
	1 15/16	1055-1 15/16G 1155-1 15/16											
	2	1055-2G 1155-2											
	2 1/8	1055-2 1/8G 1155-2 1/8											
	2 3/16	1055-2 3/16G 1155-2 3/16											

Please check availability

Shaft diameter mm inches	RHP designation		Dimensions (mm)						ISO Load ratings		Rec. max. speed rev/min	Mass (approx.) kg		
	1000G Series	1100 Series	D	C	B	s	d ₁	M	r	dynamic C _d newtons			static C _{st} newtons	
55		1060-55G	1160-55	110.000	22.00	65.10	25.44	76.00	10.00	1.50	48000	33000	2800	1.47
60		1060-60G	1160-60											
	2 ³ / ₁₆	1060-2 ³ / ₁₆ G	1160-2 ³ / ₁₆											
	2 ¹ / ₄	1060-2 ¹ / ₄ G	1160-2 ¹ / ₄											
	2 ⁷ / ₁₆	1060-2 ⁷ / ₁₆ G	1160-2 ⁷ / ₁₆											
	2 ⁷ / ₁₆	1060-2 ⁷ / ₁₆ G	1160-2 ⁷ / ₁₆											
60		1065-60G	1165-60	120.000	23.00	65.10	25.44	82.50	10.00	1.50	57500	40000	2600	2.02
65		1065-65G	1165-65											
	2 ¹ / ₂	1065-2 ¹ / ₂ G	1165-2 ¹ / ₂											
60		1070-60G	1170-60	125.000	24.00	74.60	30.24	89.00	12.00	1.50	61000	45000	2450	2.27
65		1070-65G	1170-65											
70		1070-70G	1170-70											
	2 ⁷ / ₁₆	1070-2 ⁷ / ₁₆ G	1170-2 ⁷ / ₁₆											
	2 ¹ / ₂	1070-2 ¹ / ₂ G	1170-2 ¹ / ₂											
	2 ³ / ₈	1070-2 ³ / ₈ G	1170-2 ³ / ₈											
	2 ¹ / ₁₆	1070-2 ¹ / ₁₆ G	1170-2 ¹ / ₁₆											
65		1075-65G	1175-65	130.000	25.00	77.80	33.34	94.00	12.00	1.50	66000	49500	2300	2.61
70		1075-70G	1175-70											
75		1075-75G	1175-75											
	2 ¹ / ₁₆	1075-2 ¹ / ₁₆ G	1175-2 ¹ / ₁₆											
	2 ³ / ₄	1075-2 ³ / ₄ G	1175-2 ³ / ₄											
	2 ⁷ / ₈	1075-2 ⁷ / ₈ G	1175-2 ⁷ / ₈											
	2 ¹ / ₁₆	1075-2 ¹ / ₁₆ G	1175-2 ¹ / ₁₆											
	3	1075-3G	1175-3											
75		1080-75G	1180-75	140.000	26.00	82.60	33.34	100.00	12.00	2.00	71500	54500	2150	3.23
80		1080-80G	1180-80											
	2 ¹ / ₁₆	1080-2 ¹ / ₁₆ G	1180-2 ¹ / ₁₆											
	3	1080-3G	1180-3											
	3 ³ / ₁₆	1080-3 ³ / ₁₆ G	1180-3 ³ / ₁₆											
	3 ¹ / ₄	1080-3 ¹ / ₄ G	1180-3 ¹ / ₄											
80		1085-80G	1185-80	150.000	28.00	85.70	34.15	107.10	12.00	2.00	83000	64000	2000	3.74
85		1085-85G	1185-85											
	3 ³ / ₁₆	1085-3 ³ / ₁₆ G	1185-3 ³ / ₁₆											
	3 ¹ / ₄	1085-3 ¹ / ₄ G	1185-3 ¹ / ₄											
	3 ³ / ₈	1085-3 ³ / ₈ G	1185-3 ³ / ₈											
	3 ⁷ / ₁₆	1085-3 ⁷ / ₁₆ G	1185-3 ⁷ / ₁₆											
85		1090-85G	1190-85	160.000	30.00	96.00	39.74	111.50	15.00	2.00	96000	71500	1900	4.99
90		1090-90G	1190-90											
	3 ⁷ / ₁₆	1090-3 ⁷ / ₁₆ G	1190-3 ⁷ / ₁₆											
	3 ¹ / ₂	1090-3 ¹ / ₂ G	1190-3 ¹ / ₂											
95		3095-95G		200.000	45.00	117.48	49.31	127.10	16.00	2.50	157000	122000	1600	9.53
100		3095-100G												
	4	3095-4G												

Please check availability

Self-Lube® bearing inserts

1000DECG and 1100DEC Series

1000DECG

With spherical outside diameter and eccentric collar lock

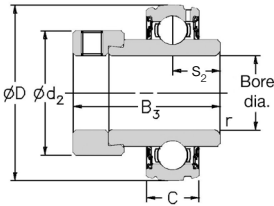

1100DEC

With parallel outside diameter and eccentric collar lock

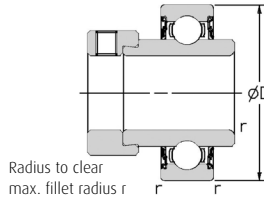

Shaft diameter mm inches	RHP designation		Dimensions (mm)							ISO Load ratings		Rec. max. speed rev/min	Mass (approx.) kg
	1000DECG Series	1100DEC Series	D	C	B ₃	s ₂	d ₂	r	dynamic newtons	static C _{0r} newtons			
20 ¾	1020-20DECG	1120-20DEC	47.000	14.00	43.73	17.13	33.30	1.00	12800	6650	6700	0.20	
25 7/8 1 1/16	1020-¾DECG	1120-¾DEC	52.000	15.00	44.43	17.53	38.10	1.00	14000	7880	6250	0.26	
	1025-25DECG	1125-25DEC											
	1025-7/8DECG	1125-7/8DEC											
30 1 1/8 1 3/16 1 1/4	1025-1 1/16 DECG	1125-1 1/16 DEC	62.000	16.00	48.43	18.33	44.50	1.00	19500	11300	5300	0.53	
	1030-30DECG	1130-30DEC											
	1030-1 1/8 DECG	1130-1 1/8 DEC											
	1030-1 3/16 DECG	1130-1 3/16 DEC											
35 1 1/4 1 3/8 1 7/16	1030-1 1/4 DECG	1130-1 1/4 DEC	72.000	17.00	51.13	18.83	55.60	1.00	25700	15300	4500	0.70	
	1035-35DECG	1135-35DEC											
	1035-1 1/4 DECG	1135-1 1/4 DEC											
	1035-1 3/8 DECG	1135-1 3/8 DEC											
40 1 1/2	1035-1 7/16 DECG	1135-1 7/16 DEC	80.000	18.00	56.33	21.43	60.30	1.00	32500	19900	4000	0.82	
	1040-40DECG	1140-40DEC											
45 1 7/8 1 11/16 1 3/4	1040-1 1/2 DECG	1140-1 1/2 DEC	85.000	19.00	56.33	21.44	63.50	1.00	32500	20500	3700	1.08	
	1045-45DECG	1145-45DEC											
	1045-1 7/8 DECG	1145-1 7/8 DEC											
	1045-1 11/16 DECG	1145-1 11/16 DEC											
50 1 7/8 1 15/16	1045-1 3/4 DECG	1145-1 3/4 DEC	90.000	20.00	62.73	24.64	69.90	1.00	35000	23200	3400	1.19	
	1050-50DECG	1150-50DEC											
	1050-1 7/8 DECG	1150-1 7/8 DEC											
55 2 2 1/8 2 3/16	1050-1 5/8 DECG	1150-1 5/8 DEC	100.000	21.00	71.42	27.84	76.20	1.50	43500	29200	3100	1.40	
	1055-55DECG	1155-55DEC											
	1055-2 DECG	1155-2DEC											
	1055-2 1/8 DECG	1155-2 1/8 DEC											
60 2 1/4 2 3/8 2 7/16	1055-2 3/16 DECG	1155-2 3/16 DEC	110.000	22.00	77.84	31.04	84.20	1.50	48000	33000	2800	1.72	
	1060-60DECG	1160-60DEC											
	1060-2 1/4 DECG	1160-2 1/4 DEC											
	1060-2 3/8 DECG	1160-2 3/8 DEC											
65 2 1/2	1060-2 7/16 DECG	1160-2 7/16 DEC	120.000	23.00	85.74	34.14	92.00	1.50	57500	40000	2600	2.21	
65	1065-2 1/2 DECG	1165-2 1/2 DEC	125.000	24.00	85.74	34.14	97.00	1.50	61000	45000	2450	2.56	
70 2 1/2 2 5/8 2 11/16	1070-65DECG	1170-65DEC	130.000	25.00	92.14	37.34	102.00	1.50	66000	49500	2300	2.94	
	1070-70DECG	1170-70DEC											
	1070-2 1/2 DECG	1170-2 1/2 DEC											
	1070-2 5/8 DECG	1170-2 5/8 DEC											
65 70 75	1070-2 11/16 DECG	1170-2 11/16 DEC	130.000	25.00	92.14	37.34	102.00	1.50	66000	49500	2300	2.94	
	1075-65DECG	1175-65DEC											
	1075-70DECG	1175-70DEC											
65 70 75	1075-75DECG	1175-75DEC	130.000	25.00	92.14	37.34	102.00	1.50	66000	49500	2300	2.94	
	1075-2 1/4 DECG	1175-2 1/4 DEC											
	1075-2 3/4 DECG	1175-2 3/4 DEC											
	1075-2 7/8 DECG	1175-2 7/8 DEC											

Please check availability

Self-Lube[®] bearing inserts 1200G and 1300 Series

1200G

With spherical outside diameter
and integral set screw lock

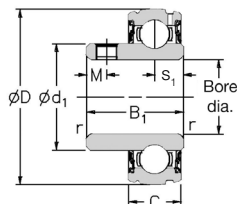

1300

With parallel outside diameter
and integral set screw lock

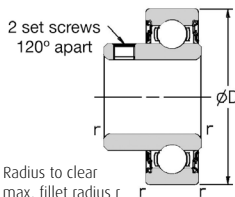

Shaft diameter mm inches	RHP designation		Dimensions (mm)							ISO Load ratings		Rec. max. speed rev/min	Mass (approx.) kg
	1200G Series	1300 Series	D	C	B ₁	s ₁	d ₁	M	r	dynamic C _r newtons	static C _{0r} newtons		
12	1217-12G		40.000	12.00	22.38	6.53	24.80	5.00	0.60	9550	4800	7000	0.08
15	1217-15G												
17	1217-17G												
5/8	1217-5/8G												
20	1220-20G	1320-20	47.000	14.00	25.80	7.53	28.30	5.00	1.00	12800	6650	6700	0.10
3/4	1220-3/4G	1320-3/4											
25	1225-25G	1325-25	52.000	15.00	27.30	7.53	34.00	5.00	1.00	14000	7880	6250	0.13
1	1225-1G	1325-1											
30	1230-30G	1330-30	62.000	16.00	31.20	9.03	40.30	5.00	1.00	19500	11300	5300	0.32
1 1/4	1230-1 1/4G	1330-1 1/4											
35	1235-35G	1335-35	72.000	17.00	34.90	9.53	46.90	6.50	1.00	25700	15300	4500	0.43
1 1/4	1235-1 1/4G	1335-1 1/4											
40	1240-40G	1340-40	80.000	18.00	41.20	11.03	52.40	8.00	1.00	32500	19900	4000	0.54
1 1/2	1240-1 1/2G	1340-1 1/2											
45	1245-45G	1345-45	85.000	19.00	41.20	11.04	57.40	8.00	1.00	32500	20500	3700	0.61
1 3/4	1245-1 3/4G	1345-1 3/4											
50	1250-50G	1350-50	90.000	20.00	43.50	11.04	62.40	10.00	1.00	35000	23200	3400	0.76

Please check availability

Self-Lube® bearing inserts

1200EC and 1200ECG Series

1300EC Series

1200EC

With spherical outside diameter, non-re-greaseable outer ring and eccentric collar lock

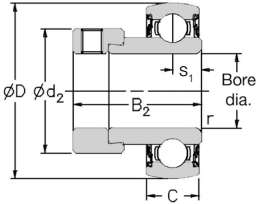

1200ECG

With spherical outside diameter, re-greaseable outer ring and eccentric collar lock

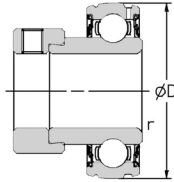

1300EC

With parallel outside diameter and eccentric collar lock

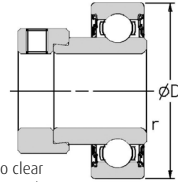

Radius to clear max. fillet radius r

Shaft diameter mm inches	RHP designation			Dimensions (mm)						ISO Load ratings		Rec. max. speed rev/min	Mass (approx.) kg
	1200EC Series	1200ECG Series	1300EC Series	D	C	B ₂	s ₁	d ₂	r	dynamic C _r newtons	static C _{0r} newtons		
12	1217-12EC	1217-12ECG	1317-12EC	40.000	12.00	28.63	6.53	28.60	0.60	9550	4800	7000	0.15
15	1217-15EC	1217-15ECG	1317-15EC										
16	1217-16EC	1217-16ECG	1317-16EC										
17	1217-17EC	1217-17ECG	1317-17EC										
½	1217-½EC	1217-½ECG	1317-½EC										
⅝	1217-⅝EC	1217-⅝ECG	1317-⅝EC										
20	1220-20EC	1220-20ECG	1320-20EC	47.000	14.00	31.03	7.53	33.30	1.00	12800	6650	6700	0.16
¾	1220-¾EC	1220-¾ECG	1320-¾EC										
25	1225-25EC	1225-25ECG	1325-25EC	52.000	15.00	31.03	7.53	38.10	1.00	14000	7880	6250	0.23
⅞	1225-⅞EC	1225-⅞ECG	1325-⅞EC										
1⅝	1225-1⅝EC	1225-1⅝ECG	1325-1⅝EC										
1	1225-1EC	1225-1ECG	1325-1EC										
30	1230-30EC	1230-30ECG	1330-30EC	62.000	16.00	35.73	9.03	44.50	1.00	19500	11300	5300	0.40
1⅛	1230-1⅛EC	1230-1⅛ECG	1330-1⅛EC										
1⅜	1230-1⅜EC	1230-1⅜ECG	1330-1⅜EC										
1¼	1230-1¼EC	1230-1¼ECG	1330-1¼EC										
35	1235-35EC	1235-35ECG	1335-35EC	72.000	17.00	38.93	9.53	55.60	1.00	25700	15300	4500	0.58
1¼	1235-1¼EC	1235-1¼ECG	1335-1¼EC										
1⅜	1235-1⅜EC	1235-1⅜ECG	1335-1⅜EC										
1⅞	1235-1⅞EC	1235-1⅞ECG	1335-1⅞EC										
40	1240-40EC	1240-40ECG	1340-40EC	80.000	18.00	43.73	11.03	60.30	1.00	32500	19900	4000	0.73
1½	1240-1½EC	1240-1½ECG	1340-1½EC										
45	1245-45EC	1245-45ECG	1345-45EC	85.000	19.00	43.73	11.04	63.50	1.00	32500	20500	3700	0.87
1⅝	1245-1⅝EC	1245-1⅝ECG	1345-1⅝EC										
1⅞	1245-1⅞EC	1245-1⅞ECG	1345-1⅞EC										
1¾	1245-1¾EC	1245-1¾ECG	1345-1¾EC										
50	1250-50EC	1250-50ECG	1350-50EC	90.000	20.00	43.73	11.04	69.90	1.00	35000	23200	3400	0.98
1⅞	1250-1⅞EC	1250-1⅞ECG	1350-1⅞EC										
1⅝	1250-1⅝EC	1250-1⅝ECG	1350-1⅝EC										
2	1250-2EC	1250-2ECG	1350-2EC										
55	1255-55ECG			100.000	21.00	48.40	12.04	76.20	1.50	43500	29200	3100	1.16
2	1255-2ECG												

Please check availability

Self-Lube® bearing inserts complete with snap ring 1100CG Series

1100CG

With parallel outside diameter and integral set screw lock

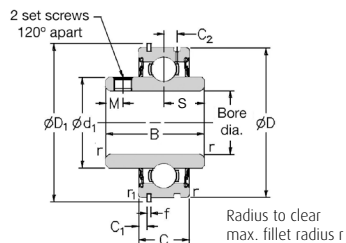

Shaft diameter mm inches	RHP designation 1100CG Series	Dimensions (mm)											ISO Load ratings		Rec. max. speed rev/min	Mass (approx.) kg	
		D	D ₁	C	C ₁	C ₂	B	s	d ₁	f	M	r	r ₁	dynamic C _r newtons			static C _{0r} newtons
20	1120-20CG	47.000	52.68	15.88	2.39	4.17	31.00	12.73	28.30	1.12	5.00	1.00	0.50	12800	6650	6700	0.23
¾	1120-¾CG																
25	1125-25CG	52.000	57.81	19.05	2.39	4.39	34.10	14.33	34.00	1.12	5.00	1.00	0.50	14000	7880	6250	0.31
7/8	1125-7/8CG																
1½/16	1125-1½/16CG																
1	1125-1CG																
30	1130-30CG	62.000	67.69	22.22	3.18	5.10	38.10	15.93	40.30	1.70	5.00	1.00	0.50	19500	11300	5300	0.42
1½	1130-1½CG																
1¾/16	1130-1¾/16CG																
35	1135-35CG	72.000	78.51	23.81	3.18	5.61	42.90	17.53	46.90	1.70	6.50	1.00	1.00	25700	15300	4500	0.61
1¼	1135-1¼CG																
1¾	1135-1¾CG																
1½	1135-1½CG																
40	1140-40CG	80.000	86.51	27.78	3.18	6.22	49.20	19.03	52.40	1.70	8.00	1.00	1.00	32500	19900	4000	0.91
1½	1140-1½CG																
45	1145-45CG	85.000	91.51	27.78	3.18	6.52	49.20	19.04	57.40	1.70	8.00	1.00	1.00	32500	20500	3700	1.05
1½	1145-1½CG																
1¾/16	1145-1¾/16CG																
1¾	1145-1¾CG																
1½	1150-1½CG	90.000	96.49	28.58	3.18	6.72	51.59	19.10	62.40	2.46	10.00	1.00	1.00	35000	23200	3400	1.10
1¾/16	1150-1¾/16CG																
55	1155-55CG	100.00	106.50	30.16	3.18	7.43	55.60	22.20	68.90	2.46	10.00	1.00	1.00	43500	29200	3100	1.50
2	1155-2CG																
2¾/16	1155-2¾/16CG																

Please check availability

Self-Lube[®] bearing inserts with adapter sleeves

1000-KG and 1100-K Series

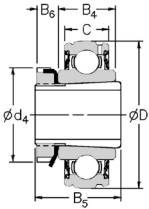

1000-KG

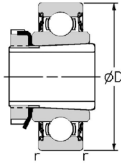

1100-K

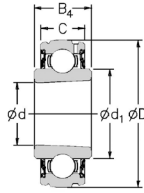

1000KG

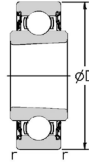

1100K

Bore taper 1:12
on diameter

Shaft diameter		RHP designation		Sleeve nut & lockwasher assembly only	Basic insert without sleeve, nut & lockwasher		Dimensions (mm)		
mm	inches	1000-KG Series	1100-K Series		1000KG	1100K	D	C	B ₄
20		1025-20KG	1125-20K	H305	1025KG	1125K	52.000	15.00	19.00
	3/4	1025-3/4KG	1125-3/4K	HE305-3/4					
25		1030-25KG	1130-25K	H306	1030KG	1130K	62.000	16.00	20.00
	15/16	1030-15/16KG	1130-15/16K	HE306-15/16					
	1	1030-1KG	1130-1K	HE306-1					
30		1035-30KG	1135-30K	H307	1035KG	1135K	72.000	17.00	21.00
	1 1/8	1035-1 1/8KG	1135-1 1/8K	HE307-1 1/8					
	1 1/16	1035-1 1/16KG	1135-1 1/16K	HE307-1 1/16					
35		1040-35KG	1140-35K	H308	1040KG	1140K	80.000	18.00	22.00
	1 1/4	1040-1 1/4KG	1140-1 1/4K	HE308-1 1/4					
	1 3/8	1040-1 3/8KG	1140-1 3/8K	HE308-1 3/8					
40		1045-40KG	1145-40K	H309	1045KG	1145K	85.000	19.00	23.00
	1 7/16	1045-1 7/16KG	1145-1 7/16K	HE309-1 7/16					
	1 1/2	1045-1 1/2KG	1145-1 1/2K	HE309-1 1/2					
45		1050-45KG	1150-45K	H310	1050KG	1150K	90.000	20.00	24.00
	1 11/16	1050-1 11/16KG	1150-1 11/16K	HE310-1 11/16					
	1 3/4	1050-1 3/4KG	1150-1 3/4K	HE310-1 3/4					
50		1055-50KG	1155-50K	H311	1055KG	1155K	100.000	21.00	25.00
	1 15/16	1055-1 15/16KG	1155-1 15/16K	HE311-1 15/16					
	2	1055-2KG	1155-2K	HE311-2					

Please check availability

Dimensions (mm)						ISO Load ratings		Rec. max. speed	Mass (approx.)
B ₅	B ₆	d	d ₁	d ₄	r	dynamic C _r newtons	static C _{0r} newtons	rev/min	kg
29.00	8.00	25.000	34.00	38.00	1.00	14000	7880	6250	0.20
31.00	8.00	30.000	40.30	45.00	1.00	19500	11300	5300	0.30
35.00	9.00	35.000	46.90	52.00	1.00	25700	15300	4500	0.42
36.00	10.00	40.000	52.40	58.00	1.00	32500	19900	4000	0.54
39.00	11.00	45.000	57.40	65.00	1.00	32500	20500	3700	0.64
42.00	12.00	50.000	62.40	70.00	1.00	35000	23200	3400	0.75
45.00	12.00	55.000	68.90	75.00	1.50	43500	29200	3100	0.95

Self-Lube[®] triple seal bearing inserts

T1000G Series

T1000G

With spherical outside diameter and integral set screw lock

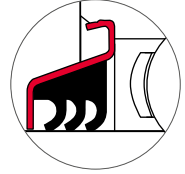
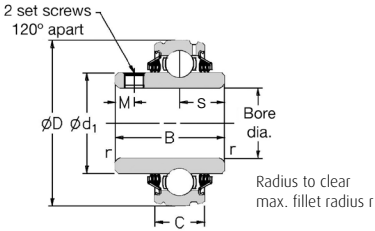

Shaft diameter mm inches	RHP designation	Dimensions (mm)							ISO Load ratings		Rec. max. speed rev/min	Mass (approx.) kg
		D	C	B	s	d ₁	M	r	dynamic C _r newtons	static C _{0r} newtons		
25	T1025-25G	52.000	15.00	34.10	14.33	34.00	5.00	1.00	14000	7880	1000	0.17
7/8	T1025-7/8G											
15/16	T1025-15/16G											
1	T1025-1G											
25	T1030-25G	62.000	18.00	38.10	15.93	40.30	5.00	1.00	19500	11300	850	0.37
30	T1030-30G											
7/8	T1030-7/8G											
1	T1030-1G											
1 1/8	T1030-1 1/8G											
1 3/16	T1030-1 3/16G											
1 1/4	T1030-1 1/4G											
30	T1035-30G	72.000	19.00	42.90	17.53	46.90	6.50	1.00	25700	15300	750	0.51
35	T1035-35G											
1 3/16	T1035-1 3/16G											
1 1/4	T1035-1 1/4G											
1 3/8	T1035-1 3/8G											
1 7/16	T1035-1 7/16G											
35	T1040-35G	80.000	21.00	49.20	19.03	52.40	8.00	1.00	32500	19900	650	0.64
40	T1040-40G											
1 3/8	T1040-1 3/8G											
1 7/16	T1040-1 7/16G											
1 1/2	T1040-1 1/2G											
40	T1045-40G	85.000	22.00	49.20	19.04	57.40	8.00	1.00	32500	20500	600	0.73
45	T1045-45G											
1 1/2	T1045-1 1/2G											
1 5/8	T1045-1 5/8G											
1 11/16	T1045-1 11/16G											
1 3/4	T1045-1 3/4G											
45	T1050-45G	90.000	23.00	51.60	19.04	62.40	10.00	1.00	35000	23200	550	0.91
50	T1050-50G											
1 11/16	T1050-1 11/16G											
1 3/4	T1050-1 3/4G											
1 7/8	T1050-1 7/8G											
1 15/16	T1050-1 15/16G											
2	T1050-2G											
50	T1055-50G	100.000	25.00	55.60	22.24	68.90	10.00	1.50	43500	29200	500	1.12
55	T1055-55G											
1 7/8	T1055-1 7/8G											
1 15/16	T1055-1 15/16G											
2	T1055-2G											
2 1/8	T1055-2 1/8G											
2 3/16	T1055-2 3/16G											

Please check availability

Shaft diameter		RHP designation	Dimensions (mm)							ISO Load ratings		Rec. max. speed rev/min	Mass (approx.) kg
mm	inches		D	C	B	s	d _i	M	r	dynamic C _d newtons	static C _{or} newtons		
55		T1060-55G	110.000	25.00	65.10	25.44	76.00	10.00	1.50	48000	33000	450	1.50
60		T1060-60G											
	2 ³ / ₁₆	T1060-2³/₁₆G											
	2 ¹ / ₄	T1060-2¹/₄G											
	2 ³ / ₈	T1060-2³/₈G											
	2 ⁷ / ₁₆	T1060-2⁷/₁₆G											
60		T1070-60G	125.000	28.00	74.60	30.24	89.00	12.00	1.50	61000	45000	400	2.30
65		T1070-65G											
70		T1070-70G											
	2 ⁷ / ₁₆	T1070-2⁷/₁₆G											
	2 ¹ / ₂	T1070-2¹/₂G											
	2 ⁵ / ₈	T1070-2⁵/₈G											
	2 ¹¹ / ₁₆	T1070-2¹¹/₁₆G											
75		T1080-75G	140.000	30.00	82.60	33.34	100.00	12.00	2.00	71500	54500	345	3.27
80		T1080-80G											
	2 ¹⁵ / ₁₆	T1080-2¹⁵/₁₆G											
	3	T1080-3G											

Please check availability

Self-Lube® triple seal bearing inserts

T1000DECG Series

T1000DECG

With spherical outside diameter and eccentric collar lock

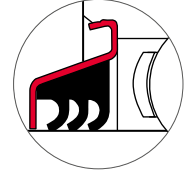
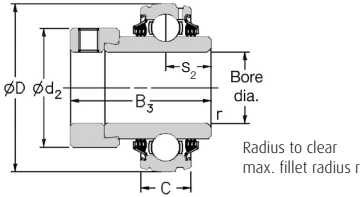

Shaft diameter		RHP designation	Dimensions (mm)					ISO Load ratings		Rec. max. speed rev/min	Mass (approx.) kg	
mm	inches		D	C	B ₃	s ₂	d ₂	r	dynamic C _r newtons			static C _{0r} newtons
25		T1025-25DECG	52.000	15.00	44.43	17.53	38.10	1.00	14000	7880	1000	0.26
	7/8	T1025-7/8DECG										
	15/16	T1025-15/16DECG										
	1	T1025-1DECG										
30		T1030-30DECG	62.000	18.00	48.43	18.33	44.50	1.00	19500	11300	850	0.53
	1 1/8	T1030-1 1/8DECG										
	1 3/16	T1030-1 3/16DECG										
	1 1/4	T1030-1 1/4DECG										
35		T1035-35DECG	72.000	19.00	51.13	18.83	55.60	1.00	25700	15300	750	0.70
	1 1/4	T1035-1 1/4DECG										
	1 3/8	T1035-1 3/8DECG										
	1 7/16	T1035-1 7/16DECG										
40		T1040-40DECG	80.000	21.00	56.33	21.43	60.30	1.00	32500	19900	650	0.82
	1 1/2	T1040-1 1/2DECG										
45		T1045-45DECG	85.000	22.00	56.33	21.44	63.50	1.00	32500	20500	600	1.08
	1 7/8	T1045-1 7/8DECG										
	1 11/16	T1045-1 11/16DECG										
	1 3/4	T1045-1 3/4DECG										
50		T1050-50DECG	90.000	23.00	62.73	24.64	69.90	1.00	35000	23200	550	1.19
	1 7/8	T1050-1 7/8DECG										
	1 15/16	T1050-1 15/16DECG										
55		T1055-55DECG	100.000	25.00	71.42	27.84	76.20	1.50	43500	29200	500	1.40
	2	T1055-2DECG										
	2 1/8	T1055-2 1/8DECG										
	2 3/16	T1055-2 3/16DECG										
60		T1060-60DECG	110.000	25.00	77.84	31.04	84.20	1.50	48000	33000	450	1.81
	2 1/4	T1060-2 1/4DECG										
	2 7/16	T1060-2 7/16DECG										
65		T1070-65DECG	125.000	28.00	85.74	34.14	97.00	1.50	61000	45000	400	2.49
70		T1070-70DECG										

Please check availability

Self-Lube[®] bearing inserts with flinger seals

1000GFS Series

1000GFS

With spherical outside diameter and integral set screw lock

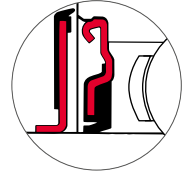
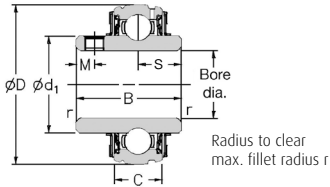

Shaft diameter		RHP designation	Dimensions (mm)							ISO Load ratings		Rec. max. speed rev/min	Mass (approx.) kg	
mm	inches		D	C	B	s	d ₁	M	r	dynamic C ₁ newtons	static C _{0r} newtons			
25		1025-25GFS	52.000	15.00	34.10	14.33	34.00	5.00	1.00	14000	7880	6250	0.17	
		1025-7/8GFS												
		1025-15/16GFS												
		1025-1GFS												
25		1030-25GFS	62.000	16.00	38.10	15.93	40.30	5.00	1.00	19500	11300	5300	0.37	
30		1030-30GFS												
		1030-7/8GFS												
		1030-1GFS												
		1030-1 1/8GFS												
		1030-1 1/16GFS												
	1030-1 1/4GFS													
30		1035-30GFS	72.000	17.00	42.90	17.53	46.90	6.50	1.00	25700	15300	4500	0.51	
	35													1035-35GFS
														1035-1 1/16GFS
														1035-1 1/4GFS
														1035-1 1/8GFS
														1035-1 3/8GFS
	1035-1 1/2GFS													
35		1040-35GFS	80.000	18.00	49.20	19.03	52.40	8.00	1.00	32500	19900	4000	0.64	
	40													1040-40GFS
														1040-1 3/8GFS
														1040-1 1/16GFS
	1040-1 1/2GFS													
40		1045-40GFS	85.000	19.00	49.20	19.04	57.40	8.00	1.00	32500	20500	3700	0.73	
	45													1045-45GFS
														1045-1 1/2GFS
														1045-1 3/8GFS
														1045-1 1/8GFS
														1045-1 1/16GFS
	1045-1 3/4GFS													
45		1050-45GFS	90.000	20.00	51.60	19.04	62.40	10.00	1.00	35000	23200	3400	0.91	
	50													1050-50GFS
														1050-1 1/16GFS
														1050-1 3/4GFS
														1050-1 7/8GFS
														1050-1 15/16GFS
	1050-2GFS													
50		1055-50GFS	100.000	21.00	55.60	22.24	68.90	10.00	1.50	43500	29200	3100	1.12	
	55													1055-55GFS
														1055-1 1/8GFS
														1055-1 1/16GFS
														1055-2GFS
														1055-2 1/8GFS
	1055-2 3/16GFS													
55		1060-55GFS	110.000	22.00	65.10	25.44	76.00	10.00	1.50	48000	33000	2800	1.47	
	60													1060-60GFS
														1060-2 3/16GFS
														1060-2 1/4GFS
														1060-2 3/8GFS
														1060-2 1/2GFS

Please check availability

Self-Lube® bearing inserts with flinger seals

1000DECGFS Series

1000DECGFS

With spherical outside diameter and eccentric collar lock

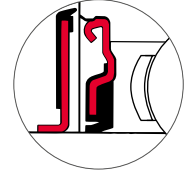
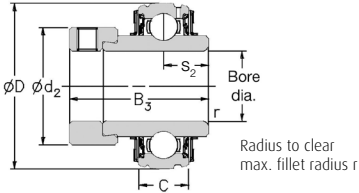

Shaft diameter		RHP designation	Dimensions (mm)					ISO Load ratings		Rec. max. speed rev/min	Mass (approx.) kg	
mm	inches		D	C	B ₃	s ₂	d ₂	r	dynamic C _r newtons			static C _{0r} newtons
25		1025-25DECGFS	52.000	15.00	44.43	17.53	38.10	1.00	14000	7880	6250	0.26
	7/8	1025-7/8DECGFS										
	1 1/16	1025-1 1/16DECGFS										
	1	1025-1DECGFS										
30		1030-30DECGFS	62.000	16.00	48.43	18.33	44.50	1.00	19500	11300	5300	0.53
	1	1030-1 1/8DECGFS										
	1 3/16	1030-1 3/16DECGFS										
	1 1/4	1030-1 1/4DECGFS										
35		1035-35DECGFS	72.000	17.00	51.13	18.83	55.60	1.00	25700	15300	4500	0.70
	1 1/4	1035-1 1/4DECGFS										
	1 5/16	1035-1 5/16DECGFS										
	1 3/8	1035-1 3/8DECGFS										
	1 7/16	1035-1 7/16DECGFS										
40		1040-40DECGFS	80.000	18.00	56.33	21.43	60.30	1.00	32500	19900	4000	0.82
	1 1/2	1040-1 1/2DECGFS										
45		1045-45DECGFS	85.000	19.00	56.33	21.44	63.50	1.00	32500	20500	3700	1.08
	1 5/8	1045-1 5/8DECGFS										
	1 11/16	1045-1 11/16DECGFS										
	1 3/4	1045-1 3/4DECGFS										
50		1050-50DECGFS	90.000	20.00	62.73	24.64	69.90	1.00	35000	23200	3400	1.19
	1 7/8	1050-1 7/8DECGFS										
	1 15/16	1050-1 15/16DECGFS										
55		1055-55DECGFS	100.000	21.00	71.42	27.84	76.20	1.50	43500	29200	3100	1.40
	2	1055-2DECGFS										
	2 1/8	1055-2 1/8DECGFS										
	2 1/16	1055-2 1/16DECGFS										
60		1060-60DECGFS	110.000	22.00	77.84	31.04	84.20	1.50	48000	33000	2800	1.72
	2 1/4	1060-2 1/4DECGFS										
	2 3/8	1060-2 3/8DECGFS										
	2 7/16	1060-2 7/16DECGFS										

Please check availability

Self-Lube® protector

The Protector Range

RHP designation	Dimensions (mm)			Basic bearing insert
	D _p	A	A ₁	
20P	37.0	23.0	30.0	1020
25P	42.5	23.0	30.5	1025
30P=2	50.5	36.0	44.0	1030
35P=2	60.5	38.5	47.0	1035
40P=1	67.5	42.0	51.0	1040
45P	72.0	30.0	39.5	1045
50P=1	76.0	46.0	56.0	1050
55P	85.0	37.5	48.0	1055
60P=1	94.0	54.0	51.5	1060

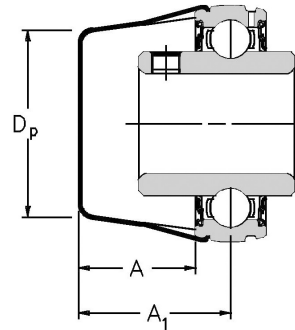

The following table shows the range of units which can be fitted with a protector and indicates the right protector to select.

Bore size	Self-Lube® unit												
	NP	SFT	SNP	LFTC	FC	ST	BT	SLFEP	SLFTP	MFC	SCHB	NP-K	MP
	NP-A	SFT-A	SNP-A	LFTC-A	FC-A	ST-A	BT-A	SLFEP-A	SLFTP-A		SCH	MP-K	MSF
	NP-EC	SFT-EC	SNP-EC	LFTC-EC	FC-EC	ST-EC	BT-EC	SLFEP-EC	SLFTP-EC			MSF-K	MSFT
	NP-DEC	SFT-DEC	SNP-DEC	LFTC-DEC	FC-DEC	ST-DEC		SLFEP-DEC	SLFTP-DEC			MSFT-K	MST
	SL	SLC	CNP	SLFLP								MST-K	MSC
	SL-A	SLC-A	CNP-A	SLFLP-A									
	SL-EC	SLC-EC	CNP-EC	SLFLP-EC									
	SL-DEC	SLC-DEC	CNP-DEC	SLFLP-DEC									
	SF												
	SF-A												
	SF-EC												
	SF-DEC												
20, 3/4	20P	20P	20P	20P	20P	20P	-	20P	-	-	20P	25P	-
25, 7/8, 15/16, 1	25P	25P	25P	25P	25P	25P	25P	25P	25P	30P=2	30P=2	30P=2	30P=2
30, 1 1/8	30P=2	30P=2	30P=2	30P=2	30P=2	30P=2	-	30P=2	30P=2	35P=2	30P=2	35P=2	35P=2
1 3/16	30P=2	30P=2	30P=2	30P=2	30P=2	30P=2	-	30P=2	30P=2	35P=2	35P=2	35P=2	35P=2
1 1/4	35P=2	35P=2	35P=2	30P=2	35P=2	35P=2	35P=2	30P=2	30P=2	35P=2	35P=2	40P=1	35P=2
35, 1 3/8	35P=2	35P=2	35P=2	35P=2	35P=2	35P=2	35P=2	35P=2	35P=2	40P=1	35P=2	40P=1	40P=1
1 7/16	35P=2	35P=2	35P=2	35P=2	35P=2	35P=2	35P=2	35P=2	35P=2	40P=1	40P=1	45P	40P=1
40, 1 1/2	40P=1	40P=1	40P=1	-	40P=1	40P=1	-	40P=1*	-	40P=1	40P=1	45P	45P
45, 1 5/8	45P	45P	45P	-	45P	45P	-	45P*	-	50P=1	50P=1	50P=1	50P=1
1 11/16, 1 3/4	45P	45P	45P	-	45P	45P	-	45P*	-	50P=1	50P=1	50P=1	50P=1
50, 1 7/8, 1 5/16	50P=1	50P=1	-	-	50P=1	50P=1	-	50P=1*	-	55P	50P=1	55P	55P
2	55P	55P	-	-	55P	55P	-	55P*	-	55P	50P=1	55P	55P
55, 2 1/8, 2 3/16	55P	55P	-	-	55P	55P	-	55P*	-	60P=1	60P=1	-	60P=1
2 1/4	60P=1	60P=1	-	-	60P=1	60P=1	-	60P=1*	-	60P=1	60P=1	-	60P=1
60, 2 3/8, 2 7/16	60P=1	60P=1	-	-	60P=1	60P=1	-	60P=1*	-	-	60P=1	-	-

* Please check availability of units (protectors are available, but special SLFEP flangelets may not be).

Note 1: The appropriate protector is determined by the basic bearing insert group.

Note 2: When a pressing from the series SLFL, SLFE or SLFT is fitted with a protector, the unit reference includes the letter "P", e.g. SLFEP-25EC.

Additional products

LF series, LFG series

A range of three bolt spheroidal graphite iron housed units, available in bore sizes 25mm to 35mm and 1" to 1⁷/₁₆".

LF series units are not re-greaseable.

LFG series units use an M5 grease nipple.

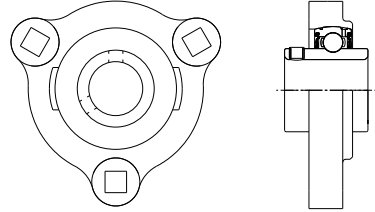

LF series

AR-A series, AR-EC series

The AR series is the bearing and rubber cartridge used in the LPBR unit (Pages 76 and 77).

Available as a series for users who have their own housing.

Bore sizes 12mm to 30mm and 1/2" to 1¹/₄".

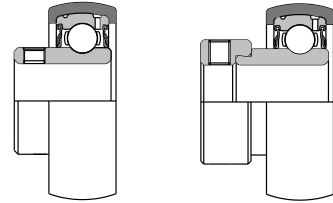

AR-A series

AR-EC series

SRM-EC series

Rubber housed units fitted with the 1120 or 1125 type inserts. Available in bore sizes 20mm, 3/4", 25mm, 7/8" and 1" with eccentric collar or set screw lock.

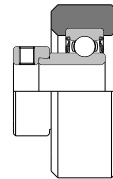

SRM-EC series

SRC-EC series

Rubber housed units suitable for the air conditioning market, two housings each with an outside diameter of 64,5mm and in bore sizes 20mm to 25mm and 3/4" to 1" are available.

Special SRC types

Bore sizes 20mm and 3/4".

Offered with eccentric collar lock.

(SRC11004 and SRC11005 respectively.)

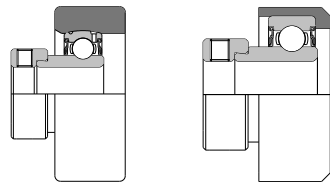

SRC-EC series

Special SRC series

2300-EC extra light series

The 2300-EC series is an extra light bearing, based on the 6000 series configuration, and is available in bore sizes 20mm to 30mm and $\frac{3}{4}$ " to $1\frac{3}{16}$ ".

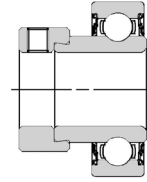

2300-EC
extra light series

1600-G series, 1600-HG series

A range of spherical outside diameter deep groove wide inner ring ball bearings with either round or hexagonal bores.

These are re-greaseable and available in round bore sizes 20mm to 75mm and $\frac{3}{4}$ " to $2\frac{15}{16}$ " and hexagonal bore sizes $\frac{7}{8}$ " AF to $1\frac{1}{2}$ " AF and 22mm AF to 38mm AF. Round bore diameters are an interference fit on the shaft.

The standard Self-Lube® cage and seals are fitted.



1600-G series

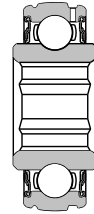

1600-HG series

1700 series, 1700-H series

As 1600-G, 1600-HG but with parallel outside diameters, although this range is not re-greaseable.

Again, round bore diameters are an interference fit on the shaft.



1700 series

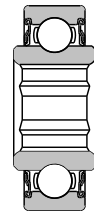

1700-H series



Silver-Lube® Bearing Units



Silver-Lube® unit references

Insert Type

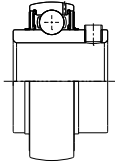

Housing Type



Page	100
------	-----

102	PNP
-----	-----



104	PSF
-----	-----



106	PSFT
-----	------



108	PST
-----	-----

Silver-Lube® insert references

J

Reverse outer
(Grease hole same side as set screw)

10

OD profile

10: Spherical outside diameter

25

Basic group

-

25

Bore size

2 Digits: Millimetre sizes
Single Digit + fractions:
Inch sizes

G

Greaseable

G: All supplied as re-greaseable

CR

Corrosion Resistant

Rings, cage, balls and flinger are corrosion resisting steels

Silver-Lube® product range

Introduction

The Silver-Lube® series is a range of corrosion resistant bearing units specifically for use in industries where frequent thorough washdowns are necessary, optimum hygiene standards are required and good chemical resistance is important over a wide temperature range.

The units are available in pillow block, two-bolt flange, four-bolt flange and take-up unit configurations and are capable of accommodating initial misalignment from mounting errors. In operation the units have proven reliability in the most hostile applications. Relubrication is possible for long trouble-free life, minimising maintenance, maximising productivity and helping maintain hygiene standards.

Silver-Lube® housings are made from PBT thermoplastic resin which, in addition to being non-corrodible, is resistant to detergents and a wide range of chemicals. The housings are paint and coating free which prevents chipping or flaking and have smooth surfaces to assist thorough washdowns.

Silver-Lube® bearing inserts are made from stainless steel, are provided with effective, efficient sealing arrangements and are charged with an aluminium complex, high temperature approved food grade grease as standard.

For Silver-Lube® bearings the radial internal clearance (RIC) is C3.

Housing strength

Housing load carrying capacity varies depending on the application loading regime, which may be intermittent, continuous or cyclical. Maximum housing loads are given in tables 1, 2, 3 and 4. These loads must not be exceeded without prior consultation with NSK.

Published housing maximum load capacities do not allow for any reduction in housing strength caused by exposure of the housing to chemicals, water, steam, heat, ultraviolet light or any combination of these factors. If any of these factors are present in the application the designer or end-user must establish the effect of these exposures and reduce the published maximum housing load accordingly.

To maximise load carrying capacity it is recommended that washers are used with the fixing bolts. Tables 1, 2 and 3 also detail maximum fixing bolt tightening torques.

Static electricity generation

Static electricity may be generated by Silver-Lube® bearing units under certain application conditions.

Silver-Lube® bearings are therefore not recommended for use in explosive or flammable environments. If Silver-Lube® bearing units are used in flammable or explosive applications the bearing insert must be earthed.

Housing strength

PNP Series

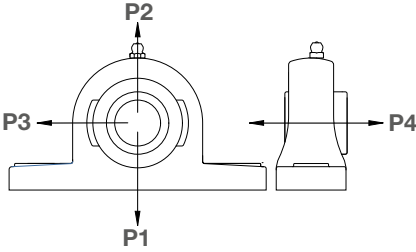

Table 1 PNP Silver-Lube® pillow block - housing load capacity

RHP designation	Maximum housing load (N) at 20°C												Max. fixing bolt torque (Nm)
	P1			P2			P3			P4			
	Intermittent loading	Continuous loading	Cyclical loading	Intermittent loading	Continuous loading	Cyclical loading	Intermittent loading	Continuous loading	Cyclical loading	Intermittent loading	Continuous loading	Cyclical loading	
PNP20CR	3500	1700	800	2800	1400	800	2600	1300	700	1300	700	400	18
PNP¾CR	3500	1700	800	2800	1400	800	2600	1300	700	1300	700	400	18
PNP25CR	4000	2000	1000	3100	1500	800	2600	1300	700	1700	900	500	25
PNP1CR	4000	2000	1000	3100	1500	800	2600	1300	700	1700	900	500	25
PNP30CR	5000	2500	1200	3500	1800	1000	4000	2000	1100	2600	1300	700	30
PNP1¾CR	5000	2500	1200	3500	1800	1000	4000	2000	1100	2600	1300	700	30
PNP1¼RCR	5000	2500	1200	3500	1800	1000	4000	2000	1100	2600	1300	700	30
PNP35CR	6000	3000	1500	4300	2100	1200	4100	2100	1100	3200	1600	900	35
PNP1½CR	6000	3000	1500	4300	2100	1200	4100	2100	1100	3200	1600	900	35
PNP1¾CR	6000	3000	1500	4300	2100	1200	4100	2100	1100	3200	1600	900	35
PNP40CR	10700	5300	2900	8000	4000	2200	6800	3400	1900	5200	2600	1400	40
PNP1½CR	10700	5300	2900	8000	4000	2200	6800	3400	1900	5200	2600	1400	40

Table 2 PSF Silver-Lube® four-bolt flange - housing load capacity

RHP designation	Maximum housing load (N) at 20°C						Max. fixing bolt torque (Nm)
	F1			F2			
	Intermittent loading	Continuous loading	Cyclical loading	Intermittent loading	Continuous loading	Cyclical loading	
PSF20CR	3100	1600	900	1300	700	400	18
PSF¾CR	3100	1600	900	1300	700	400	18
PSF25CR	3500	1700	1000	1300	700	400	25
PSF1CR	3500	1700	1000	1300	700	400	25
PSF30CR	4600	2300	1300	2200	1100	600	30
PSF1¾CR	4600	2300	1300	2200	1100	600	30
PSF1¼RCR	4600	2300	1300	2200	1100	600	30
PSF35CR	6200	3100	1700	2600	1300	700	35
PSF1½CR	6200	3100	1700	2600	1300	700	35
PSF1¾CR	6200	3100	1700	2600	1300	700	35
PSF40CR	6200	3100	1700	4000	2000	1100	40
PSF1½CR	6200	3100	1700	4000	2000	1100	40

PSF Series

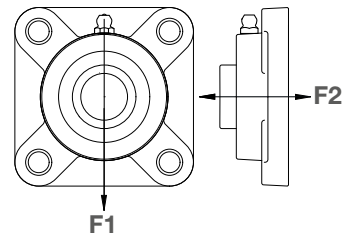

PSFT Series

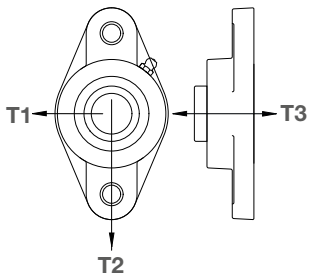

Table 3 PSFT Silver-Lube® two-bolt flange - housing load capacity

RHP designation	Maximum housing load (N) at 20°C									Max. fixing bolt torque (Nm)
	T1			T2			T3			
	Intermittent loading	Continuous loading	Cyclical loading	Intermittent loading	Continuous loading	Cyclical loading	Intermittent loading	Continuous loading	Cyclical loading	
PSFT20CR	4400	2200	1200	1900	900	500	1300	700	400	18
PSFT¾CR	4400	2200	1200	1900	900	500	1300	700	400	18
PSFT25CR	4400	2200	1200	3000	1500	800	1400	700	400	25
PSFT1CR	4400	2200	1200	3000	1500	800	1400	700	400	25
PSFT30CR	5900	2900	1600	3300	1600	900	2000	1000	500	30
PSFT1¾CR	5900	2900	1600	3300	1600	900	2000	1000	500	30
PSFT1¼RCR	5900	2900	1600	3300	1600	900	2000	1000	500	30
PSFT35CR	6400	3200	1700	3900	2000	1100	2800	1400	800	35
PSFT1¼CR	6400	3200	1700	3900	2000	1100	2800	1400	800	35
PSFT1¾CR	6400	3200	1700	3900	2000	1100	2800	1400	800	35
PSFT40CR	9000	4500	2500	3900	2000	1100	3300	1600	900	40
PSFT1½CR	9000	4500	2500	3900	2000	1100	3300	1600	900	40

Table 4 PST Silver-Lube® take-up - housing load capacity

RHP designation	Maximum housing load (N) at 20°C		
	U Intermittent loading	U Continuous loading	U Cyclical loading
PST20CR	5700	2800	1600
PST¾CR	5700	2800	1600
PST25CR	5400	2700	1500
PST1CR	5400	2700	1500
PST30CR	8100	4000	2300
PST1¾CR	8100	4000	2300
PST1¼RCR	8100	4000	2300
PST35CR	7800	3900	2200
PST1¼CR	7800	3900	2200
PST1¾CR	7800	3900	2200
PST40CR	8100	4000	2300
PST1½CR	8100	4000	2300

PST Series

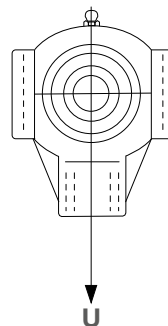

Silver-Lube® bearing inserts

Silver-Lube® bearing inserts have martensitic stainless steel rings and balls, and austenitic stainless steel ball cage, flingers and set screws, in addition to durable and heat-resistant silicone rubber seals

The grease in this product is an aluminium complex food grade grease, classified to NSF grade H1. In the event of relubricating being necessary, this type of grease is the first choice replacement.

If an aluminium complex food grade grease is not available, it is essential that any alternative grease is NSF H1 approved and ideally chemically compatible with the original grease. If chemical compatibility cannot be assured, then it is recommended that the original grease is completely flushed out of the system before relubrication. NSK should be consulted where necessary.

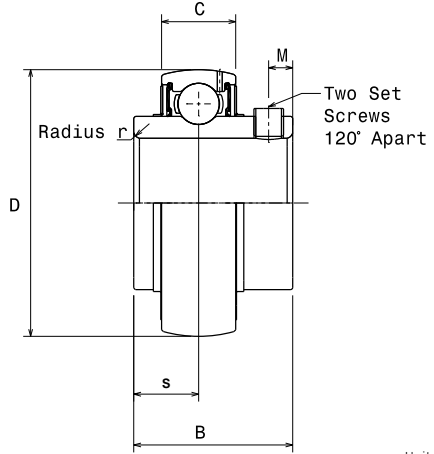

Units mm

Table 5 Insert designations, dimensions and weights

RHP designation	Bore dia	D	C	B	s	r	M	C _i (N)	C _{or} (N)	Weight (Kg)
J1020-20GCR	20	47	17	31.0	12.7	0.5	5.0	9910	5350	0.16
J1020-¾GCR	¾"	47	17	31.0	12.7	0.5	5.0	9910	5350	0.16
J1025-25GCR	25	52	17	34.1	14.3	0.5	5.0	10820	6300	0.20
J1025-1GCR	1"	52	17	34.1	14.3	0.5	5.0	10820	6300	0.20
J1030-30GCR	30	62	19	38.1	15.9	0.5	5.0	15000	9050	0.32
J1030-1⅜GCR	1⅜"	62	19	38.1	15.9	0.5	5.0	15000	9050	0.32
J1030-1¼GCR	1¼"	62	19	38.1	15.9	0.5	5.0	15000	9050	0.32
J1035-35GCR	35	72	20	42.9	17.5	1.0	6.5	19820	12300	0.48
J1035-1½GCR	1½"	72	20	42.9	17.5	1.0	6.5	19820	12300	0.48
J1035-1⅞GCR	1⅞"	72	20	42.9	17.5	1.0	6.5	19820	12300	0.48
J1040-40GCR	40	80	21	49.2	19.0	1.0	8.0	25200	15900	0.64
J1040-1½GCR	1½"	80	21	49.2	19.0	1.0	8.0	25200	15900	0.64

Shaft tolerances and permissible speeds

Bearing insert permissible speed is dependent on shaft tolerance. For higher speed applications an ISO h7 shaft tolerance is recommended. An ISO h9 shaft tolerance may be used for low speed applications. For more information see table 6.

Table 6 Tolerances and Speeds

Basic bearing insert	Bearing limiting speed (RPM)	ISO h7 Shaft tolerance high (0.001 mm Units)	ISO h7 Shaft tolerance low (0.001 mm Units)	Bearing limiting speed (RPM)	ISO h9 Shaft tolerance high (0.001 mm Units)	ISO h9 Shaft tolerance low (0.001 mm Units)
J1020	2900	0	-21	1490	0	-52
J1025	2600	0	-21	1300	0	-52
J1030	2180	0	-21	1090	0	-52
J1035	1870	0	-25	940	0	-62
J1040	1650	0	-25	830	0	-62

Materials and tightening torques

Materials

	Parts	Materials
Bearing	Bearing Rings	Martensitic stainless steel (equivalent to SUS440C)
	Ball	Martensitic stainless steel (equivalent to SUS440C)
	Flinger	Austenitic stainless steel (equivalent to SUS302)
	Rubber Seal	Silicone Rubber
	Set Screw	Austenitic stainless steel (equivalent to SUS304)
	Cage	Austenitic stainless steel (equivalent to SUS302)
Bearing housing		Thermo Plastic PBT

Set screw tightening torques

Set screws for Silver-Lube® bearing inserts are manufactured from stainless steel and can fracture if overtightened. The limiting set screw torques listed (in Table 7) should not be exceeded.

Table 7 Recommended tightening torques for set screws

Bearing designation	Designation of set screws	Maximum tightening torque (Nm)
J1020-20GCR	M6 X 1.0 X 6.0 LONG	4
J1020-3/4GCR	M6 X 1.0 X 6.0 LONG	4
J1025-25GCR	M6 X 1.0 X 6.0 LONG	4
J1025-1GCR	M6 X 1.0 X 6.0 LONG	4
J1030-30GCR	M6 X 1.0 X 6.0 LONG	4
J1030-13/16GCR	M6 X 1.0 X 6.0 LONG	4
J1030-11/4GCR	M6 X 1.0 X 6.0 LONG	4
J1035-35GCR	M8 X 1.0 X 8.0 LONG	8
J1035-11/4GCR	M8 X 1.0 X 8.0 LONG	8
J1035-17/16GCR	M8 X 1.0 X 8.0 LONG	8
J1040-40GCR	M8 X 1.0 X 8.0 LONG	8
J1040-11/2GCR	M8 X 1.0 X 8.0 LONG	8

Unit dimensions

Table 8: PNP Silver-Lube® pillow block - unit dimensions

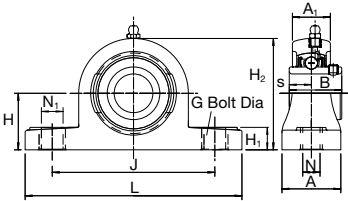

PNP Series

Shaft diameter		RHP designation	Basic bearing insert	Housing group	Dimensions (mm)				
mm	inches				L	H	H ₁	H ₂	J
20		PNP20CR	J1020	2	127.2	33.3	14.2	65.9	94.9
	¾	PNP¾CR	J1020	2	127.2	33.3	14.2	65.9	94.9
25		PNP25CR	J1025	3	140.2	36.5	14.5	71.9	104.9
	1	PNP1CR	J1025	3	140.2	36.5	14.5	71.9	104.9
30		PNP30CR	J1030	4	162.2	42.9	17.8	83.9	118.9
	1⅜	PNP1⅜CR	J1030	4	162.2	42.9	17.8	83.9	118.9
	1¼	PNP1¼RCR	J1030	4	162.2	42.9	17.8	83.9	118.9
35		PNP35CR	J1035	5	167.2	47.6	18.0	94.9	126.9
	1¼	PNP1¼CR	J1035	5	167.2	47.6	18.0	94.9	126.9
	1⅞	PNP1⅞CR	J1035	5	167.2	47.6	18.0	94.9	126.9
40		PNP40CR	J1040	6	184.2	49.2	19.5	98.9	136.8
	1½	PNP1½CR	J1040	6	184.2	49.2	19.5	98.9	136.8

All dimensions in mm except inch shaft sizes

Dimensions (mm)							Weight kg
N	N ₁	G	A	A ₁	B	s	
11.0	14.2	M10	37.8	22.5	31.0	12.7	0.27
11.0	14.2	M10	37.8	22.5	31.0	12.7	0.27
11.0	14.2	M10	37.8	24.5	34.0	14.3	0.39
11.0	14.2	M10	37.8	24.5	34.0	14.3	0.39
14.0	18.2	M12	45.8	27.0	38.1	15.9	0.52
14.0	18.2	M12	45.8	27.0	38.1	15.9	0.52
14.0	18.2	M12	45.8	27.0	38.1	15.9	0.52
14.0	18.2	M12	47.8	32.5	42.9	17.5	0.72
14.0	18.2	M12	47.8	32.5	42.9	17.5	0.72
14.0	18.2	M12	47.8	32.5	42.9	17.5	0.72
14.0	18.2	M12	53.8	36.0	49.2	19.0	0.99
14.0	18.2	M12	53.8	36.0	49.2	19.0	0.99

Unit dimensions

Table 9: PSF Silver-Lube® four-bolt flange - unit dimensions

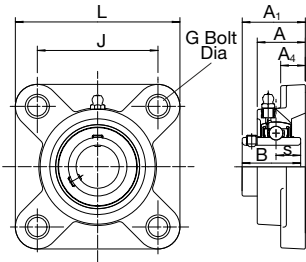

PSF Series

Shaft diameter		RHP designation	Basic bearing insert	Housing group	Dimensions (mm)		
mm	inches				L	J	G
20		PSF20CR	J1020	2	86.5	63.5	M10
	¾	PSF¾CR	J1020	2	86.5	63.5	M10
25		PSF25CR	J1025	3	95.0	70.0	M10
	1	PSF1CR	J1025	3	95.0	70.0	M10
30		PSF30CR	J1030	4	107.5	83.0	M10
	1⅜	PSF1⅜CR	J1030	4	107.5	83.0	M10
	1¼	PSF1¼RCR	J1030	4	107.5	83.0	M10
35		PSF35CR	J1035	5	117.5	92.0	M12
	1¼	PSF1¼CR	J1035	5	117.5	92.0	M12
	1⅞	PSF1⅞CR	J1035	5	117.5	92.0	M12
40		PSF40CR	J1040	6	130.5	102.0	M12
	1½	PSF1½CR	J1040	6	130.5	102.0	M12

All dimensions in mm except inch shaft sizes

Dimensions (mm)					Weight kg
A	A ₁	A ₂	B	s	
27.8	36.3	13.4	31.0	12.7	0.28
27.8	36.3	13.4	31.0	12.7	0.28
27.9	36.7	14.3	34.0	14.3	0.34
27.9	36.7	14.3	34.0	14.3	0.34
31.5	41.4	14.3	38.1	15.9	0.50
31.5	41.4	14.3	38.1	15.9	0.50
31.5	41.4	14.3	38.1	15.9	0.50
34.8	46.9	15.5	42.9	17.5	0.74
34.8	46.9	15.5	42.9	17.5	0.74
34.8	46.9	15.5	42.9	17.5	0.74
37.5	53.2	17.1	49.2	19.0	0.98
37.5	53.2	17.1	49.2	19.0	0.98

Unit dimensions

Table 10: PSFT Silver-Lube® two-bolt flange - unit dimensions

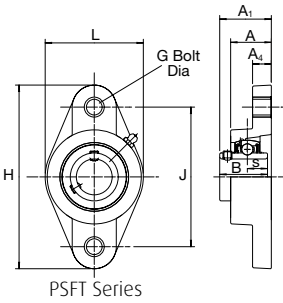

Shaft diameter		RHP designation	Basic bearing insert	Housing group	Dimensions (mm)		
mm	inches				L	H	J
20		PSFT20CR	J1020	2	64.1	113.3	90.0
	¾	PSFT¾CR	J1020	2	64.1	113.3	90.0
25		PSFT25CR	J1025	3	68.4	130.3	99.0
	1	PSFT1CR	J1025	3	68.4	130.3	99.0
30		PSFT30CR	J1030	4	80.1	148.3	117.0
	1⅜	PSFT1⅜CR	J1030	4	80.1	148.3	117.0
	¼	PSFT¼RCR	J1030	4	80.1	148.3	117.0
35		PSFT35CR	J1035	5	90.1	163.3	130.0
	¼	PSFT¼CR	J1035	5	90.1	163.3	130.0
	⅞	PSFT⅞CR	J1035	5	90.1	163.3	130.0
40		PSFT40CR	J1040	6	100.1	175.3	144.0
	½	PSFT½CR	J1040	6	100.1	175.3	144.0

All dimensions in mm except inch shaft sizes

Dimensions (mm)						Weight Kg
G	A	A ₁	A ₂	B	s	
M10	26.5	33.7	11.4	31.0	12.7	0.24
M10	26.5	33.7	11.4	31.0	12.7	0.24
M10	29.1	36.7	13.5	34.0	14.3	0.30
M10	29.1	36.7	13.5	34.0	14.3	0.30
M10	30.5	41.2	13.5	38.1	15.9	0.44
M10	30.5	41.2	13.5	38.1	15.9	0.44
M10	30.5	41.2	13.5	38.1	15.9	0.44
M12	32.8	43.4	16.1	42.9	17.5	0.64
M12	32.8	43.4	16.1	42.9	17.5	0.64
M12	32.8	43.4	16.1	42.9	17.5	0.64
M12	37.5	51.7	20.0	49.2	19.0	0.89
M12	37.5	51.7	20.0	49.2	19.0	0.89

Unit dimensions

Table 11: PST Silver-Lube® take up units - unit dimensions

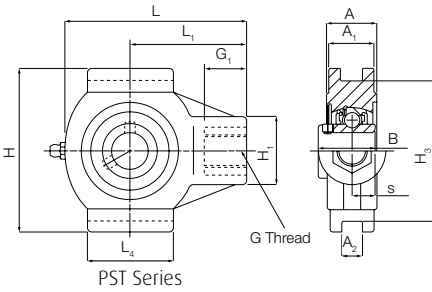

Shaft diameter mm inches	RHP designation	Basic bearing insert	Housing group	Dimensions (mm)				
				L	L ₁	L ₄	H	H ₁
20	PST20CR	J1020	2	99.0	64.0	47.0	88.0	35.0
¾	PST¾CR	J1020	2	99.0	64.0	47.0	88.0	35.0
25	PST25CR	J1025	3	99.0	64.0	47.0	88.0	35.0
1	PST1CR	J1025	3	99.0	64.0	47.0	88.0	35.0
30	PST30CR	J1030	4	125.0	76.0	63.0	102.0	40.0
⅜	PST⅜CR	J1030	4	125.0	76.0	63.0	102.0	40.0
1¼	PST1¼RCR	J1030	4	125.0	76.0	63.0	102.0	40.0
35	PST35CR	J1035	5	125.0	76.0	63.0	102.0	40.0
¼	PST¼CR	J1035	5	125.0	76.0	63.0	102.0	40.0
⅞	PST⅞CR	J1035	5	125.0	76.0	63.0	102.0	40.0
40	PST40CR	J1040	6	140.0	85.0	80.0	114.0	40.0
½	PST½CR	J1040	6	140.0	85.0	80.0	114.0	40.0

All dimensions in mm except inch shaft sizes

Dimensions (mm)								Weight kg
H ₃	G	G ₁	A	A ₁	A ₂	B	s	
75.8	M16X2.00	22.5	27.5	24.5	12.2	31.0	12.7	0.32
75.8	M16X2.00	22.5	27.5	24.5	12.2	31.0	12.7	0.32
75.8	M16X2.00	22.5	27.5	24.5	12.2	34.0	14.3	0.36
75.8	M16X2.00	22.5	27.5	24.5	12.2	34.0	14.3	0.36
88.8	M16X2.00	22.5	34.5	30.0	12.2	38.1	15.9	0.53
88.8	M16X2.00	22.5	34.5	30.0	12.2	38.1	15.9	0.53
88.8	M16X2.00	22.5	34.5	30.0	12.2	38.1	15.9	0.53
88.8	M16X2.00	22.5	34.5	30.0	12.2	42.9	17.5	0.74
88.8	M16X2.00	22.5	34.5	30.0	12.2	42.9	17.5	0.74
88.8	M16X2.00	22.5	34.5	30.0	12.2	42.9	17.5	0.74
101.8	M16X2.00	22.5	34.0	32.0	16.2	49.2	19.0	1.00
101.8	M16X2.00	22.5	34.0	32.0	16.2	49.2	19.0	1.00

End Covers

Polypropylene end covers are available to fit all Silver-Lube® housings. End covers can be used at temperatures ranging from -20°C to +90°C. They may be used as additional protection for the bearing in adverse environmental conditions as well as an aid to meeting safety requirements.

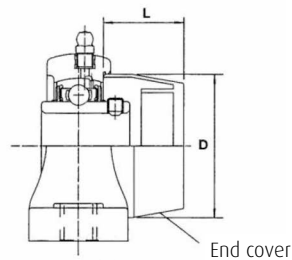

HOUSING GROUP	END COVER REFERENCE	DIMENSION D	DIMENSION L
Group 2	P20P	50.0	23.0
Group 3	P25P	55.0	25.0
Group 4	P30P	64.0	30.0
Group 5	P35P	74.0	32.0
Group 6	P40P	84.0	37.0

All dimensions in mm



Molded-Oil Inserts with Stainless Steel Housings



Molded-Oil stainless steel unit references

Insert Type

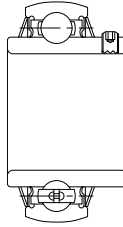

Housing Type



Page	Series
114	F-UCPM2
116	F-UCFM2

Molded-Oil insert references

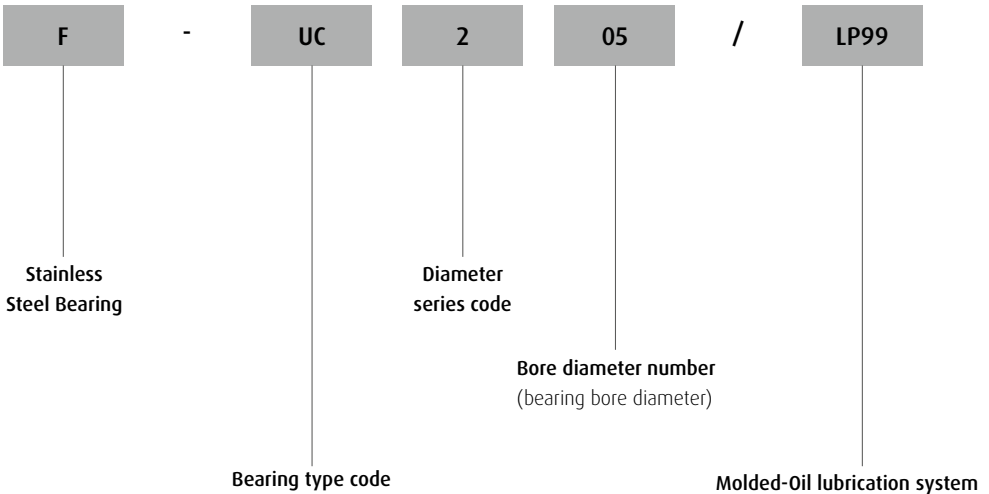

Ball bearing units stainless series

Introduction

This series provides corrosion resistance and longer lubrication life in a clean unit with low torque characteristics.

NSK ball bearing units in the stainless series feature ball bearings inserted into housings made of stainless that provide superior resistance to corrosion as compared to standard series cast iron units. This series is especially useful in a wide variety of applications because of the rust-free properties of the housing.

Molded-Oil bearings are lubricated with NSK's own oil-impregnated material, Molded-Oil. Molded-Oil consists of lubricating oil and polyolefin resin that has an affinity for oil. Oil slowly seeping from this material provides ample lubrication to the bearing for extended periods.

As oil seeping from the Molded-Oil inside the bearing provides sufficient lubrication, troublesome oil refilling is not required and contamination of the surrounding environment is prevented.

Prior to filling the bearings with Molded-Oil, their interior surfaces are specially treated. As a result, bearing torque is not much higher than that of grease-lubricated bearings.

The basic dimensions are the same as current NSK units and are also compatible with units from other manufacturers ISO standard.

Materials

	Parts	Materials
Bearing	Raceways	Martensitic stainless steel (equivalent to SUS440C)
	Ball	Martensitic stainless steel (equivalent to SUS440C)
	Flinger, Retainer	Austenitic stainless steel (equivalent to SUS304)
	Rubber Seal	Nitrile rubber
	Set Screw (W shape screw head)	Martensitic stainless steel (equivalent to SUS410)
Bearing housing		Austenitic stainless steel casting (SCS13)

Recommended operating temperature and allowable speed

Molded-Oil bearings are recommended to operate from -15 to +80°C. However, operating temperature should be below +60°C when the bearing is operated under continuous use.

dn value: $12 \cdot 10^4$ max

(dn = bore diameter in mm x speed in min⁻¹)

Remarks: This recommended operating temperature range and allowable speed is applied to all bearings with Molded-Oil bearings. Contact NSK when your application exceeds these recommendations.

Recommended tightening torques for set screws

Bearing designation (F-UC)	Designation of set screws (W shape on screw head)	Maximum tightening torque (Nm)
204, 205	M5 x 0.8	3.9
206	M6 x 0.75	4.9
207	M6 x 0.75	5.8
208-210	M8 x 1	7.8

Inner ring tolerances

Units: μm

Nominal bore diameter d		Bore diameter			Width		Radial run-out (ref.)
over mm	incl. mm	Δdmp deviations		ΔBs deviations			
		high	low	max	high	low	max
18	31.750	+18	0	12	0	-120	18
31.750	50.800	+21	0	14	0	-120	20

Δdmp : Mean bore diameter deviation.

ΔVdp : Bore diameter variation.

ΔBs : Inner ring width deviation.

Outer ring tolerances

Units: μm

Nominal outside diameter D		ΔDm deviations		Radial run-out (ref.)
over mm	incl. mm	high	low	
30	50	0	-11	20
50	80	0	-13	25
80	120	0	-15	35

ΔDm : Mean outside diameter deviation.

The lower deviation figure of ΔDm does not apply within a distance of ¼ the width of the outer ring from either side.

Pillow type ball bearing unit

F-UCPM2 series: Cylindrical bore, set screw type with Molded-Oil

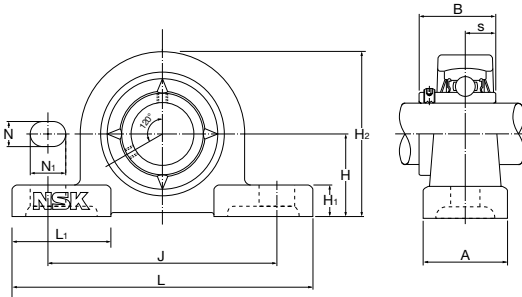

Shaft diameter mm	Unit number	Dimensions (mm)										
		H	L	J	A	N	N ₁	H ₁	H ₂	L ₁	B	s
20	F-UCPM204D0/LP99	33.3	120	95	30	12	14	11	64	42	31.0	12.7
25	F-UCPM205D0/LP99	36.5	130	105	30	12	14	12	70	42	34.1	14.3
30	F-UCPM206D0/LP99	42.9	155	121	36	17	20	13	82	54	38.1	15.9
35	F-UCPM207D0/LP99	47.6	161	127	38	17	20	14	92	54	42.9	17.5
40	F-UCPM208D0/LP99	49.2	171	137	40	17	20	14	98	52	49.2	19
45	F-UCPM209D0/LP99	54	180	146	40	17	20	14	105	60	49.2	19
50	F-UCPM210D0/LP99	57.2	195	159	45	19	22	16	114	65	51.6	19



Bolt size	Bearing number	Housing number	Mass of unit (Ref.) kg
M10	F-UC204/LP99	PM204	0.6
M10	F-UC205/LP99	PM205	0.7
M14	F-UC206/LP99	PM206	1.0
M14	F-UC207/LP99	PM207	1.3
M14	F-UC208/LP99	PM208	1.8
M14	F-UC209/LP99	PM209	2.1
M16	F-UC210/LP99	PM210	2.5

Rhombus type ball bearing unit

F-UCFM2 series: Cylindrical bore, set screw type with Molded-Oil

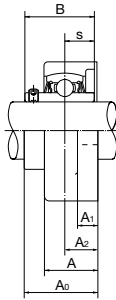
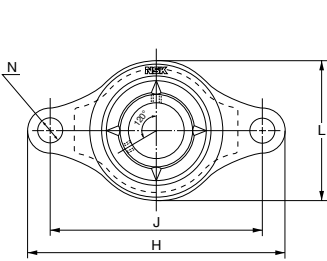

Shaft diameter mm	Unit number	Dimensions (mm)									
		H	J	A ₂	A ₁	A	N	L	A ₀	B	s
20	F-UCFM204D0/LP99	112	90	15	10	25.5	12	60	33.3	31.0	12.7
25	F-UCFM205D0/LP99	127	99	16	10	26.5	16	68	35.8	34.1	14.3
30	F-UCFM206D0/LP99	145	117	18	10	30	16	80	40.2	38.1	15.9
35	F-UCFM207D0/LP99	158	130	19	12	32	16	90	44.4	42.9	17.5
40	F-UCFM208D0/LP99	172	144	21	12	35	16	100	51.2	49.2	19
45	F-UCFM209D0/LP99	180	148	22	13	36	19	108	52.2	49.2	19
50	F-UCFM210D0/LP99	189	157	22	13	37	19	115	54.6	51.6	19



Bolt size	Bearing number	Housing number	Mass of unit (Ref.) kg
M10	F-UC204/LP99	FM204	0.5
M14	F-UC205/LP99	FM205	0.6
M14	F-UC206/LP99	FM206	0.9
M14	F-UC207/LP99	FM207	1.2
M14	F-UC208/LP99	FM208	1.6
M16	F-UC209/LP99	FM209	1.9
M16	F-UC210/LP99	FM210	2.2

Stainless insert bearing

Cylindrical bore, set screw type with Molded-Oil

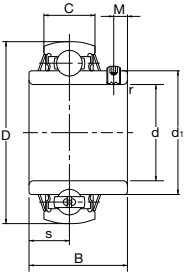

Shaft diameter mm	Unit number	Dimensions (mm)			
		D	B	C	r _{min}
20	F-UC204/LP99	47	31.0	17	1
25	F-UC205/LP99	52	34.1	17	1
30	F-UC206/LP99	62	38.1	19	1
35	F-UC207/LP99	72	42.9	20	1.5
40	F-UC208/LP99	80	49.2	21	1.5
45	F-UC209/LP99	85	49.2	22	1.5
50	F-UC210/LP99	90	51.6	24	1.5

Dimensions (mm)			Basic load rating N		Mass of unit (Ref.)
s	M	d ₁	Dynamic C _r	Static C _{or}	kg
12.7	4.5	29.6	9900	6650	0.17
14.3	5	33.9	10800	7850	0.20
15.9	5	40.8	15000	11300	0.33
17.5	6	46.8	19700	15300	0.49
19	8	53.0	22400	17800	0.65
19	8	57.5	25200	20400	0.70
19	9	62.4	27000	23300	0.80



Life-Lube® Bearing Units



Life-Lube® unit references

Insert Type



Housing Type



Page	125
------	-----

126	PNP/LP99
-----	----------



128	PSF/LP99
-----	----------



130	PSFT/LP99
-----	-----------



132	PST/LP99
-----	----------

Life-Lube® insert references

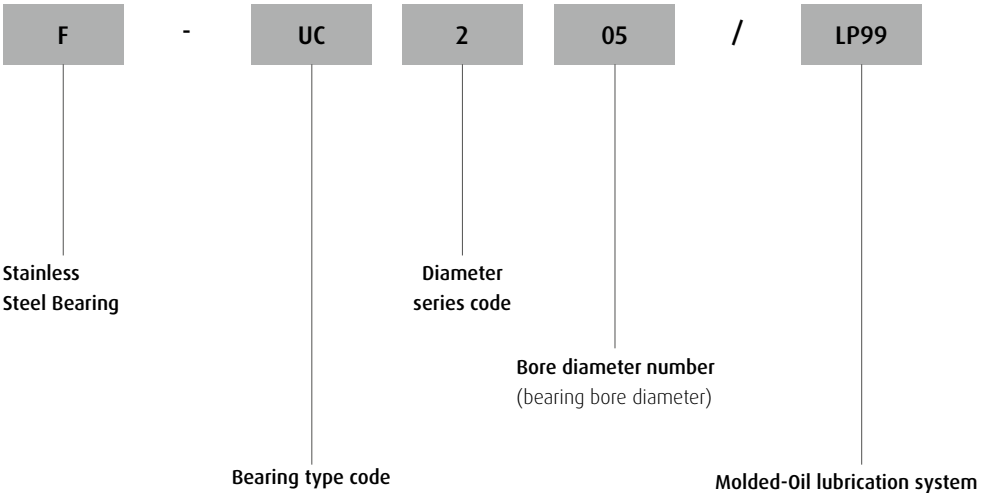

Life-Lube® product range

Introduction

The Life-Lube® series combine the corrosion resistant properties of Silver-Lube® housings with the excellent sealing and lubricating properties of Molded-Oil inserts. Life-Lube® units are specifically for use in industries where contact with water and process fluids is unavoidable, excellent chemical resistance is required and a longer lubrication life is necessary.

Life-Lube® units are available in pillow block, two-bolt flange, four-bolt flange and take-up unit configurations and are capable of accommodating initial misalignment from mounting errors. In operation, the units have proven reliability in the most hostile applications.

Life-Lube® housings are made from PBT thermoplastic resins which, in addition to being non-corrodible, are resistant to detergents and a wide range of chemicals. The housings are paint and coating free which prevents chipping or flaking and have smooth surfaces to assist in washdowns.

Life-Lube® bearing inserts are made from stainless steel which provides superior corrosion resistance. The inserts are lubricated with NSK's own oil impregnated polymer, Molded-Oil. Oil slowly seeping from this material provides ample lubrication for the bearing for extended periods. The Molded-Oil solid lubricant resists contamination and water washout and does away with the need for relubrication. Stainless steel flingers and nitrile rubber seals are fitted as standard.

Housing strength

Housing load carrying capacity varies depending on the application loading regime, which may be intermittent, continuous or cyclical. Maximum housing loads are given in tables 1, 2, 3 and 4. These loads must not be exceeded without prior consultation with NSK.

Published housing maximum load capacities do not allow for any reduction in housing strength caused by exposure of the housing to chemicals, water, steam, heat, ultraviolet light or any combination of these factors. If any of these factors are present in the application the designer or end-user must establish the effect of these exposures and reduce the published maximum housing load accordingly.

To maximise load carrying capacity it is recommended that washers are used with the fixing bolts. Tables 1, 2 and 3 also detail maximum fixing bolt tightening torques.

Static electricity generation

Static electricity may be generated by Life-Lube® bearing units under certain application conditions.

Life-Lube® bearings are therefore not recommended for use in explosive or flammable environments. If Life-Lube® bearing units are used in flammable or explosive applications the bearing insert must be earthed.

Housing strength

Table 1 PNP Life-Lube® pillow block - housing load capacity

RHP designation	Maximum housing load (N) at 20°C												Max. fixing bolt torque (Nm)
	P1			P2			P3			P4			
	Intermittent loading	Continuous loading	Cyclical loading	Intermittent loading	Continuous loading	Cyclical loading	Intermittent loading	Continuous loading	Cyclical loading	Intermittent loading	Continuous loading	Cyclical loading	
PNP20/LP99	3500	1700	800	2800	1400	800	2600	1300	700	1300	700	400	18
PNP25/LP99	4000	2000	1000	3100	1500	800	2600	1300	700	1700	900	500	25
PNP30/LP99	5000	2500	1200	3500	1800	1000	4000	2000	1100	2600	1300	700	30
PNP35/LP99	6000	3000	1500	4300	2100	1200	4100	2100	1100	3200	1600	900	35
PNP40/LP99	10700	5300	2900	8000	4000	2200	6800	3400	1900	5200	2600	1400	40

Table 2 PSF Life-Lube® four-bolt flange - housing load capacity

RHP designation	Maximum housing load (N) at 20°C						Max. fixing bolt torque (Nm)
	F1			F2			
	Intermittent loading	Continuous loading	Cyclical loading	Intermittent loading	Continuous loading	Cyclical loading	
PSF20/LP99	3100	1600	900	1300	700	400	18
PSF25/LP99	3500	1700	1000	1300	700	400	25
PSF30/LP99	4600	2300	1300	2200	1100	600	30
PSF35/LP99	6200	3100	1700	2600	1300	700	35
PSF40/LP99	6200	3100	1700	4000	2000	1100	40

Table 3 PSFT Life-Lube® two-bolt flange - housing load capacity

RHP designation	Maximum housing load (N) at 20°C									Max. fixing bolt torque (Nm)
	T1			T2			T3			
	Intermittent loading	Continuous loading	Cyclical loading	Intermittent loading	Continuous loading	Cyclical loading	Intermittent loading	Continuous loading	Cyclical loading	
PSFT20/LP99	4400	2200	1200	1900	900	500	1300	700	400	18
PSFT25/LP99	4400	2200	1200	3000	1500	800	1400	700	400	25
PSFT30/LP99	5900	2900	1600	3300	1600	900	2000	1000	500	30
PSFT35/LP99	6400	3200	1700	3900	2000	1100	2800	1400	800	35
PSFT40/LP99	9000	4500	2500	3900	2000	1100	3300	1600	900	40

Table 4 PST Life-Lube® take-up - housing load capacity

RHP designation	Maximum housing load (N) at 20°C		
	U		
	Intermittent loading	Continuous loading	Cyclical loading
PST20/LP99	5700	2800	1600
PST25/LP99	5400	2700	1500
PST30/LP99	8100	4000	2300
PST35/LP99	7800	3900	2200
PST40/LP99	8100	4000	2300

Note that there is no maximum fixing bolt torque applicable for take-up units.

PNP Series

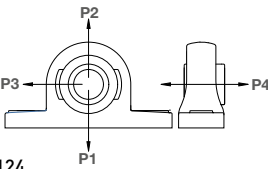

PSF Series

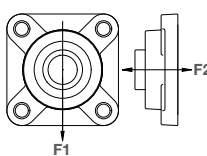

PSFT Series

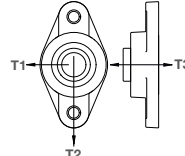

PST Series

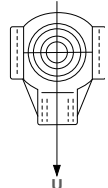

Life-Lube® bearing inserts

Life-Lube® bearing inserts have martensitic stainless steel rings, balls and set screws, and austenitic stainless steel cage and flingers.

Life-Lube® bearing inserts are lubricated with NSK's own oil-impregnated material, Molded-Oil. Molded-Oil consists of lubricating oil and polyolefin resin that has an affinity for oil. Oil slowly seeping from this material provides ample lubrication to the bearing for extended periods. Relubrication is not necessary for Life-Lube® Molded-Oil inserts.

Recommended operating temperature and allowable speed

Molded-Oil inserts are recommended to operate from -15 to +80°C. However, operating temperature should be below +60°C when the bearing is operated under continuous use.

Allowable speed:

dn value : 12×10^4 max

(dn = bore diameter in mm x speed in rpm)

Remarks: This recommended operating temperature range and allowable speed applies to all units with Molded-Oil inserts. Contact NSK when your application exceeds these recommendations.

Materials

	Parts	Materials
Bearing	Bearing Rings	Martensitic stainless steel (equivalent to SUS440C)
	Ball	Martensitic stainless steel (equivalent to SUS440C)
	Flinger	Austenitic stainless steel (equivalent to SUS302)
	Seal	Nitrile rubber
	Set Screw	Martensitic stainless steel (equivalent to SUS410)
Bearing housing		Thermo Plastic PBT

Set screw tightening torques

Set screws for Life-Lube® bearing inserts are manufactured from stainless steel and can fracture if overtightened. The limiting set screw torques listed in Table 5 should not be exceeded.

Recommended tightening torques for set screws

Insert designation	Designation of set screws	Maximum tightening torque (Nm)
F-UC204/LP99	M5 x 0.8	3.9
F-UC205/LP99	M5 x 0.8	3.9
F-UC206/LP99	M6 x 0.75	4.9
F-UC207/LP99	M6 x 0.75	5.8
F-UC208/LP99	M8 x 1	7.8

Inner ring tolerances

Units: μm

Nominal bore diameter d		Bore diameter			Width		Radial runout (ref.)
over mm	incl. mm	Δdmp deviations		ΔVdp variations max	ΔBs deviations		
		high	low		high	low	max
18	31.750	+18	0	12	0	-120	18
31.750	50.800	+21	0	14	0	-120	20

Δdmp : Mean bore diameter deviation.

ΔVdp : Bore diameter variation.

ΔBs : Inner ring width deviation.

Outer ring tolerances

Units: μm

Nominal outside diameter D		ΔDm deviations		Radial runout (ref.)
over mm	incl. mm	high	low	
		30	50	0
50	80	0	-13	25
80	120	0	-15	35

ΔDm : Mean outside diameter deviation.

The lower deviation figure of ΔDm does not apply within a distance of $\frac{1}{4}$ the width of the outer ring from either side.

Unit dimensions

Table 1: PNP/LP99 Life-Lube® pillow block - unit dimensions

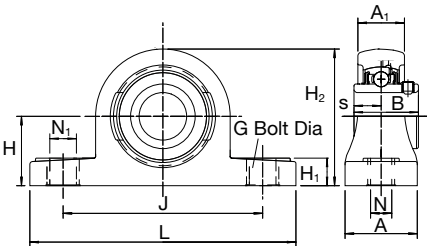

PNP/LP99 Series

Shaft diameter mm	RHP designation	Basic insert	Housing group	Dimensions (mm)			
				L	H	H ₁	H ₂
20	PNP20/LP99	F-UC204/LP99	2	127.2	33.3	14.2	65.9
25	PNP25/LP99	F-UC205/LP99	3	140.2	36.5	14.5	71.9
30	PNP30/LP99	F-UC206/LP99	4	162.2	42.9	17.8	83.9
35	PNP35/LP99	F-UC207/LP99	5	167.2	47.6	18.0	94.9
40	PNP40/LP99	F-UC208/LP99	6	184.2	49.2	19.5	98.9

Dimensions (mm)								Weight kg
J	N	N ₁	G	A	A ₁	B	s	
94.9	11	14.2	M10	37.8	22.5	31.0	12.7	0.27
104.9	11	14.2	M10	37.8	24.5	34.0	14.3	0.39
118.9	14	18.2	M12	45.8	27.0	38.1	15.9	0.52
126.9	14	18.2	M12	47.8	32.5	42.9	17.5	0.72
136.8	14	18.2	M12	53.8	36.0	49.2	19.0	0.99

Unit dimensions

Table 2: PSF/LP99 Life-Lube® four-bolt flange - unit dimensions

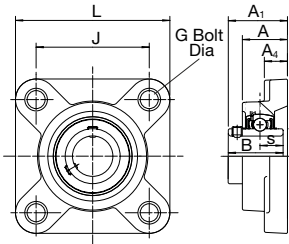

PSF/LP99 Series

Shaft diameter mm	RHP designation	Basic insert	Housing group	Dimensions (mm)		
				L	J	G
20	PSF20/LP99	F-UC204/LP99	2	86.5	63.5	M10
25	PSF25/LP99	F-UC205/LP99	3	95.0	70.0	M10
30	PSF30/LP99	F-UC206/LP99	4	107.5	83.0	M10
35	PSF35/LP99	F-UC207/LP99	5	117.5	92.0	M12
40	PSF40/LP99	F-UC208/LP99	6	130.5	102.0	M12

Dimensions (mm)					Weight kg
A	A ₁	A ₄	B	s	
27.8	36.3	13.4	31.0	12.7	0.28
27.9	36.7	14.3	34.0	14.3	0.34
31.5	41.4	14.3	38.1	15.9	0.50
34.8	46.9	15.5	42.9	17.5	0.74
37.5	53.2	17.1	49.2	19.0	0.99

Unit dimensions

Table 3: PSFT/LP99 Life-Lube® two-bolt flange - unit dimensions

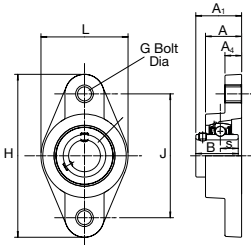

PSFT/LP99 SERIES

Shaft diameter mm	RHP designation	Basic insert	Housing group	Dimensions (mm)		
				L	H	J
20	PSFT20/LP99	F-UC204/LP99	2	64.1	113.3	90.0
25	PSFT25/LP99	F-UC205/LP99	3	68.4	130.3	99.0
30	PSFT30/LP99	F-UC206/LP99	4	80.1	148.3	117.0
35	PSFT35/LP99	F-UC207/LP99	5	90.1	163.3	130.0
40	PSFT40/LP99	F-UC208/LP99	6	100.1	175.3	144.0

G	Dimensions (mm)					Weight kg
	A	A₁	A₂	B	s	
M10	26.5	33.7	11.4	31.0	12.7	0.24
M10	29.1	36.7	13.4	34.0	14.3	0.30
M10	30.5	41.2	13.4	38.1	15.9	0.44
M12	32.8	43.4	16.1	42.9	17.5	0.64
M12	37.5	51.7	20.0	49.2	19.0	0.89

Unit dimensions

Table 4: PST/LP99 Life-Lube® take up - unit dimensions

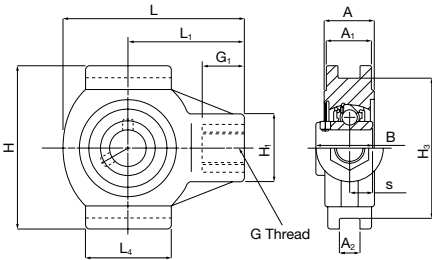

PST/LP99 Series

Shaft diameter mm	RHP designation	Basic insert	Housing group	Dimensions (mm)				
				L	L ₁	L ₄	H	H ₁
20	PST20/LP99	F-UC204/LP99	2	99.0	64.0	47.0	88.0	35.0
25	PST25/LP99	F-UC205/LP99	3	99.0	64.0	47.0	88.0	35.0
30	PST30/LP99	F-UC206/LP99	4	125.0	76.0	63.0	102.0	40.0
35	PST35/LP99	F-UC207/LP99	5	125.0	76.0	63.0	102.0	40.0
40	PST40/LP99	F-UC208/LP99	6	140.0	85.0	80.0	114.0	40.0

Dimensions (mm)								Weight kg
H ₃	G	G ₁	A	A ₁	A ₂	B	s	
75.8	M16X2.00	22.5	27.5	24.5	12.2	31.0	12.7	0.32
75.8	M16X2.00	22.5	27.5	24.5	12.2	34.0	14.3	0.36
88.8	M16X2.00	22.5	34.5	30.0	12.2	38.1	15.9	0.53
88.8	M16X2.00	22.5	34.5	30.0	12.2	42.9	17.5	0.74
101.8	M16X2.00	22.5	34.0	32.0	16.2	49.2	19.0	1.00

End Covers

Polypropylene end covers are available to fit all Life-Lube® housings. End covers can be used at temperatures ranging from -20°C to +90°C. They may be used as additional protection for the bearing in adverse environmental conditions as well as an aid to meeting safety requirements.

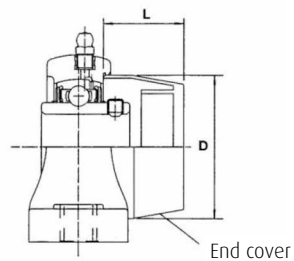

HOUSING GROUP	END COVER REFERENCE	DIMENSION D	DIMENSION L
Group 2	P20P	50.0	23.0
Group 3	P25P	55.0	25.0
Group 4	P30P	64.0	30.0
Group 5	P35P	74.0	32.0
Group 6	P40P	84.0	37.0

All dimensions in mm

Life-Lube® insert bearing

Cylindrical bore, set screw type with Molded-Oil

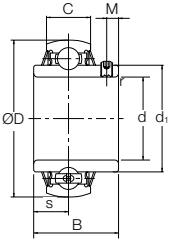

Shaft diameter mm	Unit number	Dimensions (mm)			
		D	B	C	r_{min}
20	F-UC204/LP99	47	31	17	1
25	F-UC205/LP99	52	34.1	17	1
30	F-UC206/LP99	62	38.1	19	1
35	F-UC207/LP99	72	42.9	20	1.5
40	F-UC208/LP99	80	49.2	21	1.5
45	F-UC209/LP99	85	49.2	22	1.5
50	F-UC210/LP99	90	51.6	24	1.5

Dimensions (mm)			Basic load rating N		Mass (approx.)
s	M	d ₁	Dynamic C _r	Static C _{or}	kg
12.7	4.5	29.6	9900	6650	0.17
14.3	5	33.9	10800	7850	0.20
15.9	5	40.8	15000	11300	0.33
17.5	6	46.8	19700	15300	0.49
19	8	53.0	22400	17800	0.65
19	8	57.5	25200	20400	0.70
19	9	62.4	27000	23000	0.80





Additional products

By design the Self-Lube® family of mounted units can be combined to form alternative ranges of insert and housing depending on customer requirements. This is relatively straightforward but NSK should always be consulted.

In addition NSK recognises the need for 'tailor made' solutions and is always willing to help customers who have a requirement for something out of the ordinary, commensurate with meeting certain price and volume criteria.

NSK has facilities to make special batches of product combinations such as:

- Alternative insert / housing combinations
- Special grease types and grease fills
- Alternative seal combinations - flinger seals, triple lip seals and shields

Please contact NSK with your requirements.

Special Housing Options

Where there are requirements for original equipment NSK can design special housings to accommodate customers' requirements subject to volumes required.

A typical example of this is shown below.

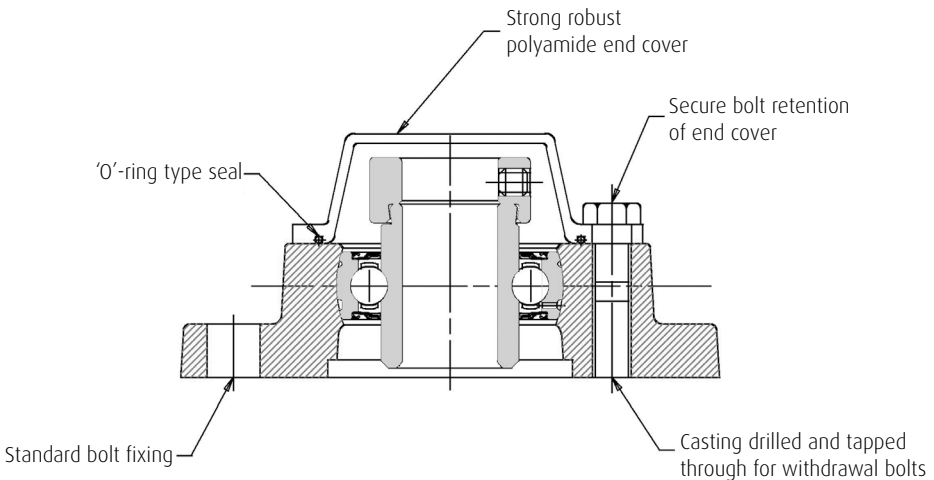

Interchange list

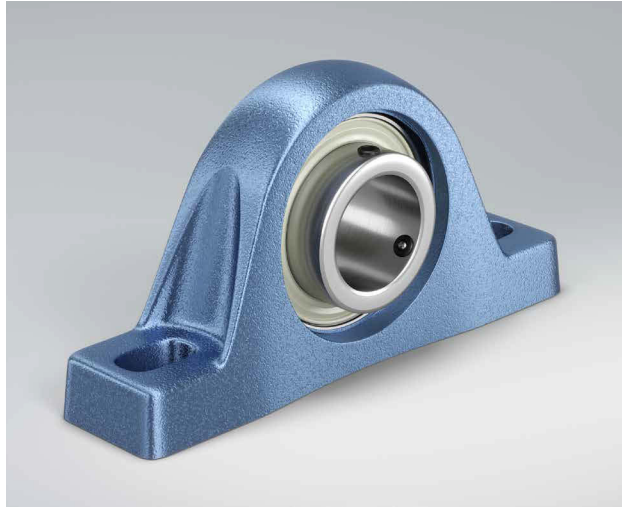

Interchange list

Series reference	Manufacturer	RHP and NSK replacement bearing series	
B	Asahi	1200G	RHP
B200	Asahi	AS200	RHP
B-B	Asahi	1200G	RHP
BF200	Asahi	SF-A	RHP
BFC200	Asahi	FC-A	RHP
BFL200	Asahi	SFT-A	RHP
BLCTE200	Asahi	ASFD200	NSK
BP200	Asahi	NP-A	RHP
BPF	Asahi	SLFE-A	RHP
BPF200	Asahi	ASPF200	NSK
BPFL	Asahi	SLFA	RHP
BPFL200	Asahi	ASPFL200	NSK
BPP	Asahi	LPB-A	RHP
BPP200	Asahi	ASPP200	NSK
BT200	Asahi	ST-A	RHP
CS200ZZ	Asahi	CS200LLU	RHP
FHF200	Asahi	FC-EC	RHP
FHLCTE200	Asahi	AELFD200	NSK
FHPF200	Asahi	AELPF200	NSK
FHPFL200	Asahi	AELPFL200	NSK
FHR200ER(U)	Asahi	1300EC	RHP
FHT200	Asahi	ST-EC	RHP
KH200+ER	Asahi	AEL200	NSK
SER	Asahi	1100CG	RHP
UC300	Asahi	UC300	NSK
UCEH200	Asahi	UCHB200	NSK
UCF200	Asahi	UCF200	NSK
UCFC200	Asahi	UCFC200	NSK
UCFCX00	Asahi	UCFCX00	NSK
UCFK200	Asahi	UCFH200	NSK
UCFL200	Asahi	UCFL200	NSK
UCFLX00	Asahi	UCFLX00	NSK
UCFX00	Asahi	UCFX00	NSK
UCLF200(U)	Asahi	SF	RHP
UCLP200(U)	Asahi	SL	RHP
UCP200	Asahi	UCP200	NSK
UCPA200	Asahi	UCUP200	NSK
UCPX00	Asahi	UCPX00	NSK
UCST200(U)	Asahi	ST	RHP
UCT200	Asahi	UCT200	NSK
UCW200	Asahi	1000G	RHP
UD200EEA	Asahi	1200CEG	RHP
UDF200A	Asahi	SF-EC	RHP
UDFL200B	Asahi	SFT-EC	RHP
UDT200A	Asahi	NP-EC	RHP
UDT200B	Asahi	ST-EC	RHP
UG200+ER	Asahi	UEL200	NSK
UGF200	Asahi	UELF200	NSK
UGFC200	Asahi	UELFC200	NSK
UGFL200	Asahi	UEFL200	NSK
UGP200	Asahi	UELP200	NSK
UGT200	Asahi	UELT200	NSK
UH200OUR(U)	Asahi	1200EC	RHP
UHF200	Asahi	SF-EC	RHP
UHFL200	Asahi	SFT-EC	RHP
UHP200	Asahi	NP-EC	RHP
UHPP200	Asahi	AELPP200	NSK
UK200	Asahi	UK200	NSK
UCP200	Asahi, FYH, Koyo, Nachi, NBR, NSK, NTN	NP	RHP
UCT200	Asahi, FYH, Koyo, Nachi, NBR, NSK, NTN	ST	RHP
UCPX	Asahi, FYH, Koyo, NSK	MP	RHP

Series reference	Manufacturer	RHP and NSK replacement bearing series	
UCTX	Asahi, FYH, Koyo, NSK	MST	RHP
UCX	Asahi, FYH, Koyo, NSK	1000G	RHP
UC200	Asahi, FYN, Koyo, Nachi, NBR, NSK, NTN	1000G	RHP
UCF200	Asahi, FYN, Koyo, Nachi, NBR, NSK, NTN	SF	RHP
UCFL200	Asahi, FYN, Koyo, Nachi, NBR, NSK, NTN	SFT	RHP
UCFX	Asahi, FYN, Koyo, NSK	MSF	RHP
UCLFX	Asahi, FYN, Koyo, NSK	MSFT	RHP
FG200ER(U)	Asahi, Nachi	1000DECG	RHP
FGAK200	Asahi, Nachi	SL-DEC	RHP
FH200ER(U)	Asahi, Nachi	1200EC	RHP
FNR-R	BCA	SF-EC	RHP
PNR-R	BCA	SL-EC	RHP
PNR-RS	BCA	NP-EC	RHP
PWG-R	BCA	SL-DEC	RHP
PWG-RS	BCA	NP-DEC	RHP
TNR-R	BCA	SFT-EC	RHP
FB200	Browning	SF-EC	RHP
FB230	Browning	SFT-EC	RHP
FB250	Browning	SF	RHP
FB260	Browning	SFT	RHP
FB350	Browning	MSF	RHP
PB200	Browning	SL-EC	RHP
PB221	Browning	NP-EC	RHP
PB250	Browning	SL	RHP
PB251	Browning	NP	RHP
PB350	Browning	MP	RHP
1000KRR	Fafnir	1100DEC	RHP
200NPPB	Fafnir	1726200-2RS	RHP
FLCTE	Fafnir	LFTC-EC	RHP
GC-KRRB	Fafnir	1000G	RHP
GC-KRRG2	Fafnir	1100CG	RHP
GE-KPPB	Fafnir	T1000DECG	RHP
GE-KRRB	Fafnir	1000DECG	RHP
G-KPPB3	Fafnir	T1000DECG	RHP
GLCTE	Fafnir	LFTC-EC	RHP
GRAE-NPPB	Fafnir	1200CEG	RHP
GW208PPB5	Fafnir	1/PDNF240/9G	RHP
GW208PPB6	Fafnir	1/PDNF240/8G	RHP
GW208PPB8	Fafnir	PDNF240/9G	RHP
GW209PPB11	Fafnir	28/DNF245-45G	RHP
GW209PPB2	Fafnir	PDNF145-45G	RHP
GW209PPB5	Fafnir	PDNF245/10G	RHP
GW209PPB8	Fafnir	DNF245/10G	RHP
GW210PP4	Fafnir	PDF150/9G	RHP
GW210PPB2	Fafnir	PDNF150-1.15/16G	RHP
GW210PPB4	Fafnir	PDNF150/9G	RHP
GW211PP2	Fafnir	PDF155-2.3/16G	RHP
GW211PP3	Fafnir	PDF155/12G	RHP
PASE	Fafnir	NP-EC	RHP
PB	Fafnir	LPB-EC	RHP
PCF	Fafnir	SF-EC	RHP
PCFT	Fafnir	SFT-EC	RHP
PHE	Fafnir	SCH-EC	RHP
PMNE	Fafnir	FC-EC	RHP
PSHE	Fafnir	SNP-EC	RHP
PTUE	Fafnir	ST-EC	RHP

Series reference	Manufacturer	RHP and NSK replacement bearing series	
RA	Fafnir	SLFE-EC	RHP
RAE..NPP	Fafnir	1300EC	RHP
RAKC	Fafnir	SL	RHP
RAKHP	Fafnir	MP	RHP
RASC	Fafnir	NP	RHP
RASE	Fafnir	NP-DEC	RHP
RAT	Fafnir	SLFL-EC	RHP
RATR	Fafnir	SLFT-EC	RHP
RC	Fafnir	SLC-DEC	RHP
RCC	Fafnir	SLC	RHP
RCE	Fafnir	SLC-DEC	RHP
RCHP	Fafnir	MSC	RHP
RCJ	Fafnir	SF-DEC	RHP
RCJHP	Fafnir	MSF	RHP
RCJSP	Fafnir	SF	RHP
RCJT	Fafnir	SFT-DEC	RHP
RCJTC	Fafnir	SFT	RHP
RCJTE	Fafnir	SFT-DEC	RHP
RCJTHP	Fafnir	MSFT	RHP
RCJTP	Fafnir	SFT	RHP
RFC	Fafnir	MFC	RHP
RFHP	Fafnir	MFC	RHP
RHCM	Fafnir	SCHB	RHP
RHE	Fafnir	SCH-DEC	RHP
RMNE	Fafnir	FC-DEC	RHP
RMNEY	Fafnir	FC	RHP
RPB	Fafnir	LPBR-EC	RHP
RR	Fafnir	SLFE-DEC	RHP
RRC	Fafnir	SLFE	RHP
RRT	Fafnir	SLFL-DEC	RHP
RRTR	Fafnir	SLFT-DEC	RHP
RSHE	Fafnir	SNP-DEC	RHP
RTUE	Fafnir	ST-DEC	RHP
RTUHP	Fafnir	MST	RHP
RTUP	Fafnir	ST	RHP
TAS	Fafnir	TNP-DEC	RHP
TASE	Fafnir	TNP-DEC	RHP
TCJ	Fafnir	TSF-DEC	RHP
TCJT	Fafnir	TSFT-DEC	RHP
THE	Fafnir	TSCH-DEC	RHP
TMNE	Fafnir	TFC-DEC	RHP
TMNE	Fafnir	TFC-DEC	RHP
TSHE	Fafnir	TSNP-DEC	RHP
TTUE	Fafnir	TST-DEC	RHP
VAK	Fafnir	SL-EC	RHP
VAK	Fafnir	SL-EC	RHP
VAS	Fafnir	NP-EC	RHP
VAS	Fafnir	NP-EC	RHP
V CJ	Fafnir	SF-EC	RHP
V CJ	Fafnir	SF-EC	RHP
V CJT	Fafnir	SFT-EC	RHP
V CJT	Fafnir	SFT-EC	RHP
VMNE	Fafnir	FC-EC	RHP
VMNE	Fafnir	FC-EC	RHP
VSHE	Fafnir	SNP-EC	RHP
VSHE	Fafnir	SNP-EC	RHP
W208PP10	Fafnir	36/DF140-1.12	RHP
W208PP5	Fafnir	2/DF240/9	RHP
W208PP6	Fafnir	2/DF240/8	RHP
W208PP8	Fafnir	PDF240/9	RHP
W208PP9	Fafnir	PDNF240/8	RHP
W208PPB13	Fafnir	2/DF240/7	RHP
W208PPB2	Fafnir	36/PDNF140-1.12	RHP
W208PPB4	Fafnir	PDNF140-1.316	RHP
W208PPB5	Fafnir	2/DF240/9	RHP
W208PPB6	Fafnir	2/DF240/8	RHP

Series reference	Manufacturer	RHP and NSK replacement bearing series	
W208PPB7	Fafnir	2/DF140-1.316	RHP
W208PPB8	Fafnir	PDNF240/9	RHP
W208PPB9	Fafnir	PDNF240/8	RHP
W209PPB2	Fafnir	PDNF145-45	RHP
W209PPB4	Fafnir	28/PDNF145-1.12	RHP
W209PPB5	Fafnir	PDNF245/10	RHP
W209PPB8	Fafnir	DNF245/10	RHP
W210PP2	Fafnir	PDF150-1.1516	RHP
W210PP4	Fafnir	PDF150/9	RHP
W210PPB2	Fafnir	PDNF150-1.1516	RHP
W210PPB4	Fafnir	PDNF150/9	RHP
W210PPB5	Fafnir	5/PDNF150-1.34	RHP
W210PPB6	Fafnir	PDNF250/9	RHP
W211PP2	Fafnir	PDF155-2.316	RHP
W211PP3	Fafnir	PDF155/12	RHP
W211PPB2	Fafnir	PDNF155-2.316	RHP
W211PPB3	Fafnir	PDF155/12	RHP
200NPPB	Fafnir, INA	1726200-2RS	RHP
GE-KPPB3	Fafnir, INA	I1000DECG	RHP
G-KRRB	Fafnir, INA	1000DECG	RHP
GRA-NPPB	Fafnir, INA	1200ECG	RHP
PB	Fafnir, INA	LPB-EC	RHP
RAE-NPPB	Fafnir, INA	1200EC	RHP
RAK	Fafnir, INA	SL-DEC	RHP
RA-NPP	Fafnir, INA	1300EC	RHP
RA-NPPB	Fafnir, INA	1200EC	RHP
RSHE	Fafnir, INA	SNP-DEC	RHP
TC-J	Fafnir, INA	TSF-DEC	RHP
TCJT	Fafnir, INA	TSFT-DEC	RHP
36200	FAG	1000DECG	RHP
56200	FAG	1000G	RHP
76200	FAG	1726200-2RS	RHP
76200B.2RSR	FAG	1726200-2RS	RHP
FB16200	FAG	SLFE-EC	RHP
FB56200	FAG	SLFE	RHP
FG16200	FAG	SF-EC	RHP
FG56200	FAG	SF	RHP
H	FAG	H	RHP
KM	FAG	AN	RHP
SB16200	FAG	LPB-EC	RHP
SC16200	FAG	NP-EC	RHP
SG36200	FAG	NP-DEC	RHP
SG56200	FAG	NP	RHP
E200	FYH	1100CG	RHP
NA200	FYH	1000DECG	RHP
NANF200	FYH	SF-DEC	RHP
NANFL200	FYH	SFT-DEC	RHP
NAP200	FYH	NP-DEC	RHP
NASL200	FYH	SL-DEC	RHP
NAT-E	FYH	ST-DEC	RHP
RB200	FYH	1100	RHP
SA200	FYH	1200EC	RHP
SAA200	FYH	1300EC	RHP
SAF-FE	FYH	SF-EC	RHP
SAFL-FE	FYH	SFT-EC	RHP
SAP200	FYH	NP-EC	RHP
SAPF200	FYH	SLFE-EC	RHP
SAPP200F	FYH	LPB-A	RHP
SASL200F	FYH	SL-EC	RHP
SBPF200	FYH	SLFL-A	RHP
SBPP200F	FYH	LPB-EC	RHP
SC200	FYH	1726200-2RS	RHP
UCHA200	FYH	SCHB	RHP
UCS200N	FYH	1100CG	RHP

Interchange list

Series reference	Manufacturer	RHP and NSK replacement bearing series	
UK200	FYH, Koyo, Nachi, NBR, NSK, NTN	1000-KG	RHP
UKP200	FYH, Koyo, Nachi, NBR, NSK, NTN	RHP	
UCPA200	FYH, Koyo, NSK	SNP	RHP
UCF200	FYH, Koyo, NSK, NTN	FC	RHP
UKT200	FYH, Koyo, NSK, NTN	MST1000-K	RHP
UKF200	FYH, Nachi, NBR, NSK, NTN	MSF1000-K	RHP
UKFL200	FYH, Nachi, NBR, NSK, NTN	MSFT1000-K	RHP
SB200	FYH, NBR	1200G	RHP
EW	Hoffmann, Pollard	FT	RHP
RMS	Hoffmann, Pollard	MRJ	RHP
2-NPPB	INA	1726200-2RS	RHP
E..KRR	INA	1100DEC	RHP
E-KRR	INA	1100DEC	RHP
FLCTE	INA	LFTC-EC	RHP
FLCTE / GLCTE	INA	LFTC-EC	RHP
FLCTEY	INA	LFTC-A	RHP
G..KRRBW	INA	1000DEC	RHP
GAY-NPPB	INA	1200G	RHP
GE..KRRB FA101T	INA	1000DEC	RHP
GE..KRRB-CC	INA	1000DEC	RHP
GE-KPPB3	INA	T1000DECG	RHP
GE-KRRB	INA	1000DECG	RHP
GLCTE	INA	LFTC-EC	RHP
GLCTEY	INA	LFTC-A	RHP
GRA..NPPBW	INA	1200ECG	RHP
GRAE-NPPB	INA	1200ECG	RHP
GSH-RRB	INA	1000KG	RHP
GY..KRRBW	INA	1000G	RHP
GYE..KRRB VA	INA	J1000GCR	RHP
GYE-KRRB	INA	1000G	RHP
GY-KRRB	INA	1000G	RHP
PAK	INA	SL-EC	RHP
PAKY	INA	SL-EC	RHP
PASE	INA	NP-EC	RHP
PASEY	INA	NP-A	RHP
PB	INA	LPB-EC	RHP
PBY	INA	LPB-A	RHP
PCJ	INA	SF-EC	RHP
PCJT	INA	SFT-EC	RHP
PCJTY	INA	SFT-A	RHP
PCJY	INA	SF-A	RHP
PHE	INA	SCH-EC / SCHB-EC	RHP
PHEY	INA	SCH-A / SCHB-A	RHP
PHUSE	INA	BT-EC+ BTHF	RHP
PME	INA	FC-EC	RHP
PMEY	INA	FC-A	RHP
PSHE	INA	SNP-EC	RHP
PSHEY	INA	SNP-A	RHP
PTUE	INA	ST-EC	RHP
PTUEY	INA	ST-A	RHP
RA	INA	SLFE-EC	RHP
RA..NPPW	INA	1300EC	RHP
RACEY	INA	NP	RHP
RAE..NPP	INA	1300EC	RHP
RAKY	INA	SL	RHP
RASE	INA	NP-DEC	RHP
RASE..FA101T	INA	NP-HLT	RHP
RASEA	INA	NP1000KG	RHP

Series reference	Manufacturer	RHP and NSK replacement bearing series	
RASEY	INA	NP	RHP
RASEY..TN VA	INA	PNP-CR	RHP
RAT	INA	SLFL-EC	RHP
RATR	INA	SLFT-EC	RHP
RATRY	INA	SLFT-A	RHP
RATY	INA	SLFL-A	RHP
RAY	INA	SLFE-A	RHP
RB	INA	LPB-DEC	RHP
RBV	INA	LPB	RHP
RCJ	INA	SF-DEC	RHP
RCJ..FA101T	INA	SF-HLT	RHP
RCJT	INA	SFT-DEC	RHP
RCJT..FA101T	INA	SFT-HLT	RHP
RCJTA	INA	SFT1000KG	RHP
RCJTY	INA	SFT	RHP
RCJY	INA	SF	RHP
RCJY..TN VA	INA	PSF-CR	RHP
RHE	INA	SCH-DEC / SCHB-DEC	RHP
RHEY	INA	SCH/SCHB	RHP
RME	INA	FC-DEC	RHP
RMEY	INA	FC	RHP
RR	INA	SLFE-DEC	RHP
RRT	INA	SLFL-DEC	RHP
RRTR	INA	SLFT-DEC	RHP
RRTY	INA	SLFL	RHP
RRY	INA	SLFE	RHP
RSHE	INA	SNP-DEC	RHP
RSHEY	INA	SNP	RHP
RTT	INA	TSLFL-DEC	RHP
RTRR	INA	TSLFT-DEC	RHP
RTUE	INA	ST-DEC	RHP
RTUEY	INA	ST	RHP
TASE	INA	TNP-DEC	RHP
TASE	INA	TNP-DEC	RHP
TB	INA	TLPB-DEC	RHP
TCJ	INA	TSF-DEC	RHP
TCJT	INA	TSFT-DEC	RHP
TCJTY..TN VA	INA	PSFT-CR	RHP
THE	INA	TSCH-DEC / TSCHB-DEC	RHP
TME	INA	TFC-DEC	RHP
TME	INA	TFC-DEC	RHP
TR	INA	TSLFE-DEC	RHP
TSHE	INA	TSNP-DEC	RHP
TSHE	INA	TSNP-DEC	RHP
TTUE	INA	TST-DEC	RHP
TTUE	INA	TST-DEC	RHP
YE-KRR	INA	1100	RHP
Y-KRR	INA	1100	RHP
CB200	Koyo	172620000-2RS	RHP
GAT100-2RSB	Koyo	1000DECG	RHP
GAP1100B	Koyo	NP-EC	RHP
GAPL1100B	Koyo	SL-DEC	RHP
GARA100-2RSA	Koyo	1200ECG	RHP
GARAF100A	Koyo	SF-EC	RHP
GARAF1100A	Koyo	SFT-EC	RHP
GARAP100A	Koyo	NP-EC	RHP
GARAPL100A	Koyo	SL-EC	RHP
GFF1100B	Koyo	SF-DEC	RHP
GFFL1100B	Koyo	SFT-DEC	RHP
HFC	Koyo	MFC	RHP
HV-(M)	Koyo	MST	RHP
LC	Koyo	SLC	RHP
LV-(M)	Koyo	ST	RHP
PB	Koyo	1200G	RHP
PF-A	Koyo	SLFE-EC	RHP
PF-M	Koyo	SLFE	RHP

Series reference	Manufacturer	RHP and NSK replacement bearing series	
PFT1100B	Koyo	SLFE-DEC	RHP
RA100	Koyo	T200EC	RHP
SCHB	Koyo	SCHB	RHP
SP	Koyo	LPB-A	RHP
SP100A	Koyo	LPB-EC	RHP
F3Y200N	Link Belt	SF-DEC	RHP
FX3Y200N	Link Belt	SFT-DEC	RHP
P3Y200N	Link Belt	NP-DEC	RHP
PL3Y200N	Link Belt	SL-DEC	RHP
C25	McGill	NP	RHP
C35	McGill	MP	RHP
CL25	McGill	SL	RHP
FC2-25	McGill	SFT	RHP
FC2-35	McGill	MSFT	RHP
FC4-25	McGill	SF	RHP
FC4-35	McGill	MSF	RHP
ER	McGill, Sealmaster	1100CG	RHP
BPF-B	Nachi	SLFE-A	RHP
BPP-B	Nachi	LPB-A	RHP
FHPR200	Nachi	LPBR-EC	RHP
SA200	NBR	T200ECG	RHP
SAFL200	NBR	SLFL-EC	RHP
SAP200	NBR	LPB-EC	RHP
SAY200	NBR	SLFE-EC	RHP
SBF200	NBR	SLFE-A	RHP
SBFL200	NBR	SLFL-A	RHP
SBP200	NBR	LPB-A	RHP
2FE	NDH	SFT-EC	RHP
2FS	NDH	SFT	RHP
4FE	NDH	SF-EC	RHP
4FS	NDH	SF	RHP
HPE	NDH	NP-EC	RHP
HPS	NDH	NP	RHP
PE	NDH	SL-EC	RHP
PS	NDH	SL	RHP
R2FE	NDH	SFT-EC	RHP
R2FS	NDH	SFT	RHP
R4FE	NDH	SF-EC	RHP
R4FS	NDH	SF	RHP
RHPE	NDH	NP-EC	RHP
RHPS	NDH	NP	RHP
RPE	NDH	SL-EC	RHP
RPS	NDH	SL	RHP
CS-DDU	NSK	1726200-2RS	RHP
EM200	NSK	1200EC	RHP
EMR200	NSK	1300EC	RHP
EN200	NSK	1200EC	RHP
ENFL200	NSK	SFT-EC	RHP
ENP200	NSK	NP-EC	RHP
ENPF200	NSK	SLFE-EC	RHP
ENPP200	NSK	LPB-EC	RHP
ENPPR200	NSK	LPBR-EC	RHP
ENR200	NSK	1300EC	RHP
EW200	NSK	1000DECG	RHP
EWFC200	NSK	FC-DEC	RHP
EFWH200	NSK	SF-DEC	RHP
EWFL200	NSK	SFT-DEC	RHP
EWFLH200	NSK	TSFT-DEC	RHP
EW200	NSK	NP-DEC	RHP
EWPA200	NSK	SNP-DEC	RHP
EWPLL200	NSK	SL-DEC	RHP
EWT200	NSK	ST-DEC	RHP
GEM200	NSK	T200ECG	RHP
GEMTR200J	NSK	ST-EC	RHP
UB200	NSK	T200G	RHP
UBF200	NSK	SF-A	RHP

Series reference	Manufacturer	RHP and NSK replacement bearing series	
UBFC200	NSK	FC-A	RHP
UBFD200	NSK	LFTC-A	RHP
UBFL200	NSK	SFT-A	RHP
UBP200	NSK	NP-A	RHP
UBPD200	NSK	SNP-A	RHP
UBPF200	NSK	SLFE-A	RHP
UBPP200	NSK	LPBR-A	RHP
UCFH200	NSK	SCHB	RHP
AEL200	NTN	T200ECG	RHP
AEL200	NTN	AEL200	NSK
AELF200	NTN	SF-EC	RHP
AELFC200	NTN	FC-EC	RHP
AELFD200	NTN	AELFD200	NSK
AELFL200	NTN	SFT-EC	RHP
AELP200	NTN	NP-EC	RHP
AELPF200	NTN	SLFE-EC	RHP
AELPF200	NTN	AELPF200	NSK
AELPFL200	NTN	AELPFL200	NSK
AELPL200	NTN	SL-EC	RHP
AELPP200	NTN	LPB-EC	RHP
AELPP200	NTN	AELPP200	NSK
AELPW200	NTN	SNP-EC	RHP
AELRPP200	NTN	LPBR-EC	RHP
AELS200	NTN	1300EC	RHP
AELT200	NTN	ST-EC	RHP
AS200	NTN	T200G	RHP
AS200	NTN	AS200	NSK
ASF200	NTN	SF-A	RHP
ASFC200	NTN	FC-A	RHP
ASFD200	NTN	LFTC-A	RHP
ASFD200	NTN	ASFD200	NSK
ASFL200	NTN	SFT-A	RHP
ASFW200	NTN	LFTC-A	RHP
ASP200	NTN	NP-A	RHP
ASPF200	NTN	SLFE-A	RHP
ASPF200	NTN	ASPF200	NSK
ASPFL200	NTN	ASPFL200	NSK
ASPL200	NTN	SL	RHP
ASPP200	NTN	LPB-A	RHP
ASPP200	NTN	ASPP200	NSK
ASPW200	NTN	SNP-A	RHP
AST200	NTN	ST-A	RHP
CS200LLU	NTN	CS200LLU	RHP
CS-LLU	NTN	1726200-2RS	RHP
UC300	NTN	UC300	NSK
UCF200	NTN	UCF200	NSK
UCF300	NTN	UCF300	NSK
UCFC200	NTN	UCFC200	NSK
UCFC300	NTN	UCFC300	NSK
UCFCX00	NTN	UCFCX00	NSK
UCFH200	NTN	UCFH200	NSK
UCFL200	NTN	UCFL200	NSK
UCFL300	NTN	UCFL300	NSK
UCFLX00	NTN	UCFLX00	NSK
UCFX00	NTN	UCFX00	NSK
UCHB	NTN	SCHB	RHP
UCHB200	NTN	UCHB200	NSK
UCP200	NTN	UCP200	NSK
UCP300	NTN	UCP300	NSK
UCPX00	NTN	UCPX00	NSK
UCS200	NTN	1100	RHP
UCT200	NTN	UCT200	NSK
UCT300	NTN	UCT300	NSK
UCTX00	NTN	UCTX00	NSK
UCUP200	NTN	UCUP200	NSK
UCX00	NTN	UCX00	NSK

Interchange list

Series reference	Manufacturer	RHP and NSK replacement bearing series	
UEL200	NTN	1000DECG	RHP
UEL200	NTN	UEL200	NSK
UELF200	NTN	SF-DEC	RHP
UELF200	NTN	UELF200	NSK
UELFC200	NTN	FC-DEC	RHP
UELFC200	NTN	UELFC200	NSK
UELFL200	NTN	SFT-DEC	RHP
UELFL200	NTN	UELFL200	NSK
UEL200	NTN	NP-DEC	RHP
UEL200	NTN	UEL200	NSK
UELPL200	NTN	SL-DEC	RHP
UELPW200	NTN	SNP-DEC	RHP
UELS200	NTN	1100DEC	RHP
UELT200	NTN	ST-DEC	RHP
UELT200	NTN	UELT200	NSK
UK200	NTN	UK200	NSK
RMS-E	Pollard	MMRJ	RHP
KLNJ	R&M	KLNJ	RHP
KLNJ-D	R&M	KLNJ-Z	RHP
KLNJ-DD	R&M	KLNJ-ZZ	RHP
KLNJ-WSR	R&M	KLNJ-2RS	RHP
630300	RIV	1000G	RHP
5300	Sealmaster	1000G	RHP
5200('C)	Sealmaster	1000G	RHP
5300('C)	Sealmaster	1000G	RHP
MFC	Sealmaster	MFC	RHP
MP	Sealmaster	MP	RHP
MSC	Sealmaster	MSC	RHP
MSF	Sealmaster	MSF	RHP
MSFT	Sealmaster	MSFT	RHP
MST	Sealmaster	MST	RHP
NP	Sealmaster	NP	RHP
SCHB	Sealmaster	SCHB	RHP
SFT	Sealmaster	SFT	RHP
SLG	Sealmaster	SL	RHP
SRP	Sealmaster	LPBR	RHP
SSF	Sealmaster	SLFE	RHP
SSP	Sealmaster	LPB	RHP
ST	Sealmaster	ST	RHP
TB	Sealmaster	CNP	RHP
TB-('C)	Sealmaster	CNP	RHP
SC	Sealmaster	SLC	RHP
SF	Sealmaster	SF	RHP
173200	SKF	1200ECCG	RHP
173600	SKF	1200EC	RHP
174600	SKF	1300EC	RHP
477200	SKF	1000DECG	RHP
479200	SKF	1000G	RHP
1716200D-2LS	SKF	1300EC	RHP
1726200-2RS	SKF	1726200-2RS	RHP
1726200-2RS1	SKF	1726200-2RS	RHP
1726300-2RS1	SKF	1726300-2RS	RHP
238200(D)-2LS	SKF	1200EC	RHP
413200(D)	SKF	1000G	RHP
FY-CB	SKF	SF-EC	RHP
FYC-RM	SKF	FC-A	RHP
FYC-TF	SKF	FC	RHP
FYC-WM	SKF	FC-DEC	RHP
FY-FM	SKF	SF-EC	RHP
FYGF-FJ	SKF	FC-EC	RHP
FYGF-SD	SKF	FC	RHP
FYGF-W	SKF	FC-DEC	RHP
FYJ-FM	SKF	SF-EC	RHP
FYJ-RM	SKF	SF-A	RHP
FYJ-TF	SKF	UCF200	RHP
FYJ-WF	SKF	UELF200	RHP

Series reference	Manufacturer	RHP and NSK replacement bearing series	
FYK..TH/GFA	SKF	PSF-CR	RHP
FY-RM	SKF	SF-A	RHP
FY-S	SKF	SF	RHP
FYTB-CB	SKF	SFT-EC	RHP
FYTB-FJ	SKF	SFT-EC	RHP
FYTB-FM	SKF	SFT-EC	RHP
FYTB-FM	SKF	SFT-EC	RHP
FYTB-FM	SKF	SFT-EC	RHP
FYTBJ-RM	SKF	SFT-A	RHP
FYTBJ-TF	SKF	UCFL200	RHP
FYTBJ-WF	SKF	UELFL200	RHP
FYTBK..TH/GFA	SKF	PSFT-CR	RHP
FYTB-L(D)	SKF	SFT	RHP
FYTB-RM	SKF	SFT-A	RHP
FYTB-S(D)	SKF	SFT	RHP
FYTB-TF	SKF	SFT	RHP
FYTB-TM	SKF	SFT	RHP
FYTB-W(M)	SKF	SFT-DEC	RHP
FYTB-WF	SKF	SFT-DEC	RHP
FY-TF	SKF	SF	RHP
FYTF-FJ	SKF	LFTC-EC	RHP
FY-TM	SKF	SF	RHP
FY-WM	SKF	SF-DEC	RHP
FY-X	SKF	SF-DEC	RHP
H	SKF	H	RHP
HA	SKF	HA	RHP
HE	SKF	HE	RHP
KM	SKF	AN	RHP
MB	SKF	AW	RHP
P-CA	SKF	LPB-EC	RHP
PF-CA	SKF	SLFE-EC	RHP
PFD-FM	SKF	SLFT-DEC	RHP
PFD-FM	SKF	SLFT-EC	RHP
PFD-RM	SKF	SLFT-A	RHP
PFD-TF	SKF	SLFT	RHP
PFD-TM	SKF	SLFT	RHP
PFD-WF	SKF	SLFT-DEC	RHP
PFD-WM	SKF	SLFT-DEC	RHP
PF-FM	SKF	SLFE-EC	RHP
P-FJ	SKF	LPB-EC	RHP
PF-L(D)	SKF	SLFE	RHP
P-FM	SKF	LPB-EC	RHP
PF-PA	SKF	SLFE-EC	RHP
PF-RM	SKF	SLFE-A	RHP
PFT-CA	SKF	SLFE-EC	RHP
PF-TF	SKF	SLFE	RHP
PFT-FM	SKF	SLFL-EC	RHP
PF-TM	SKF	SLFE	RHP
PFT-RM	SKF	SLFL-A	RHP
PFT-TF	SKF	SLFL	RHP
PFT-TM	SKF	SLFL	RHP
PFT-W	SKF	SLFL-DEC	RHP
PFT-WF	SKF	SLFL-DEC	RHP
PFT-WM	SKF	SLFL-DEC	RHP
PF-WF	SKF	SLFE-DEC	RHP
PF-WM	SKF	SLFE-DEC	RHP
P-L(D)	SKF	LPB	RHP
P-R-CA	SKF	LPBR-A	RHP
P-R-FA	SKF	LPBR-A	RHP
P-R-FJ	SKF	LPBR-A	RHP
P-R-L	SKF	LPBR	RHP
P-RM	SKF	LPB-A or ASPP200	RHP
P-TF	SKF	LPB	RHP
P-TM	SKF	LPB	RHP
P-W	SKF	LPB-DEC	RHP
P-WF	SKF	LPB-DEC	RHP
P-WM	SKF	LPB-DEC	RHP

Series reference	Manufacturer	RHP and NSK replacement bearing series	
SY	SKF	NP	RHP
SYB-FM	SKF	SL-EC	RHP
SYB-L(D)	SKF	SL	RHP
SYB-TM	SKF	SL	RHP
SYBWM	SKF	SL-DEC	RHP
SY-CB	SKF	NP-EC	RHP
SYF-FM	SKF	SNP-EC	RHP
SYFJ-FM	SKF	SNP-EC	RHP
SYFJ-RM	SKF	SNP-A	RHP
SYFJ-TF	SKF	UCUP200	NSK
SYFJ-WF	SKF	SNP-DEC	RHP
SY-FM	SKF	NP-EC	RHP
SY-FM	SKF	NP-EC	RHP
SYF-RM	SKF	SNP-A	RHP
SYF-TF	SKF	SNP	RHP
SYF-WF	SKF	SNP-DEC	RHP
SYH-CB	SKF	SL-EC	RHP
SYH-X	SKF	SL-DEC	RHP
SYJ-FM	SKF	NP-EC	RHP
SYJ-RM	SKF	NP-A	RHP
SYJ-TF	SKF	UCP200	NSK
SYJ-WF	SKF	UEL200	NSK
SYK...TH/GFA	SKF	PNP-CR	RHP
SY-RM	SKF	NP-A	RHP
SY-TF	SKF	NP	RHP
SY-TM	SKF	NP	RHP
SY-W	SKF	NP-DEC	RHP
SY-WF	SKF	NP-DEC	RHP
SY-WM	SKF	NP-DEC	RHP
TB	SKF	ST	RHP
TB-CB	SKF	ST-EC	RHP
TB-X	SKF	ST-DEC	RHP
TU-FJ	SKF	ST-EC	RHP
TU-FM	SKF	ST-EC	RHP
TU-FM	SKF	ST-EC	RHP
TUJ-FM	SKF	ST-EC	RHP
TUJ-RM	SKF	ST-A	RHP
TUJ-TF	SKF	UCT200	NSK
TUJ-WF	SKF	UEL200	NSK
TU-L(D)	SKF	ST	RHP
TU-RM	SKF	ST-A	RHP
TU-S(D)	SKF	ST	RHP
TU-TF	SKF	ST	RHP
TU-TM	SKF	ST	RHP
TU-WF	SKF	ST-DEC	RHP
TU-WM	SKF	ST-DEC	RHP
YAR2...2RF/ HVGFA	SKF	J1000GCR	RHP
YAR200	SKF	1000G	RHP
YAR-2-2RF	SKF	1000GFS	RHP
YAR-2F	SKF	1000G	RHP
YAT200	SKF	1200G	RHP
YEL200	SKF	1000DECG	RHP
YEL200-2F	SKF	1000DECG	RHP
YET200	SKF	1200ECG	RHP
YSA200-2FK	SKF	1000KG	RHP
CES200	SNR	1300EC	RHP
CEX200	SNR	1100DEC	RHP
CUC200	SNR	1100	RHP
CUCS200	SNR	1300	RHP
ES200	SNR	1200ECG	RHP
ESC200	SNR	SLC-EC	RHP
ESEHE200	SNR	SCH-EC	RHP
ESF200	SNR	SF-EC	RHP
ESFC200	SNR	FC-EC	RHP
ESFD	SNR	LFTC-EC	RHP

Series reference	Manufacturer	RHP and NSK replacement bearing series	
ESFL200	SNR	SFT-EC	RHP
ESP200	SNR	NP-EC	RHP
ESPA200	SNR	SNP-EC	RHP
ESSP200	SNR	BT-EC	RHP
EST200	SNR	ST-EC	RHP
EX200	SNR	1000DECG	RHP
EX200L3	SNR	T1000DECG8	RHP
EXC200	SNR	SLC-DEC	RHP
EXEHE200	SNR	SCH-DEC	RHP
EXF200	SNR	SF-DEC	RHP
EXFC200	SNR	FC-DEC	RHP
EXP200	SNR	NP-DEC	RHP
EXPA200	SNR	SNP-DEC	RHP
EXSP200	SNR	BT-DEC	RHP
EXT200	SNR	ST-DEC	RHP
GNP	SNR	PNP-CR	RHP
GSF	SNR	PSF-CR	RHP
GSFT	SNR	PSFT-CR	RHP
MUC...FD	SNR	J1000GCR	RHP
SPR	SNR	BTHF	RHP
UC200	SNR	1000G	RHP
UC200L3	SNR	T1000G	RHP
UCC200	SNR	SLC	RHP
UCEHE200	SNR	SCH	RHP
UCF200	SNR	SF	RHP
UCFC200	SNR	FC	RHP
UCFL200	SNR	SFT	RHP
UCP200	SNR	NP	RHP
UCPA200	SNR	SNP	RHP
UCSP200	SNR	BT	RHP
UCT200	SNR	ST	RHP
UK200	SNR	1000KG	RHP
UKC200	SNR	SLC1000K	RHP
UKEHE200	SNR	SCH1000K	RHP
UKF200	SNR	SF1000K	RHP
UKFL200	SNR	SFT1000K	RHP
UKP200	SNR	NP1000K	RHP
UKPA200	SNR	SNP1000K	RHP
UKT200	SNR	ST1000K	RHP
US200	SNR	1200G	RHP
USEC200	SNR	SLC-A	RHP
USEHE200	SNR	SCH-A	RHP
USF200	SNR	SF-A	RHP
USFC200	SNR	FC-A	RHP
USFD	SNR	LFTC-A	RHP
USFL200	SNR	SFT-A	RHP
USP200	SNR	NP-A	RHP
USPA200	SNR	SNP-A	RHP
USSP200	SNR	BT-A	RHP
UST200	SNR	ST-A	RHP
6200EES	Steyr	176200-2RS	RHP



Conversion tables



Conversion Tables

Comparison of SI, CGS and engineering units

Units Unit system	Length	Mass	Time	Temp.	Acceleration	Force	Stress	Pressure	Energy	Power
SI	m	kg	s	K, °C	m/s ²	N	Pa	Pa	J	W
CGS System	cm	g	s	°C	Gal	dyn	dyn/cm ²	dyn/cm ²	erg	erg/s
Engineering unit system	m	kgf · s ² /m	s	°C	m/s ²	kgf	kgf/m ²	kgf/m ²	kgf · m	kgf · m/s

Conversion factors from SI units

Parameter	SI Unit		Unit other than SI		Conversion factor from SI unit
	Names of unit	Symbol	Name of unit	Symbol	
Angle	Radian	rad	Degree	°	180/π
			Minute	'	10 800/π
			Second	"	648 000/π
Length	Metre	m	Micron	μ	10 ⁶
			Angstrom	Å	10 ¹⁰
Area	Square metre	m ²	Are	a	10 ²
			Hectare	ha	10 ⁴
Volume	Cubic metre	m ³	Litre	l, L	10 ³
			Decilitre	dl, dL	10 ⁴
Time	Second	s	Minute	min	1/60
			Hour	h	1/3 600
			Day	d	1/86 400
Frequency	Hertz	Hz	Cycle	s ⁻¹	1
Speed of Rotation	Revolution per second	s ⁻¹	Revolution per minute	rpm	60
Speed	Metre per second	m/s	Kilometre per hour	km/h	3 600/1 000
			Knot	kn	3 600/1 852
Acceleration	Metre per second per second	m/s ²	Gravitational acceleration	G	1/9.806 65
Mass	Kilogram	kg	Tonne	te	10 ³
			Ton	t	9.842 x 10 ⁻⁴
Force	Newton	N	Kilogram-force	kgf	1/9.806 65
			Ton-force	tf	1/(9.806 65 · 103)
			Dyne	dyn	10 ⁵
Torque or Moment	Newton · metre	N · m	Kilogram-force metre	kgf · m	1/9.806 65
Stress	Pascal	Pa (N/m ²)	Kilogram-force per square centimetre	kgf/cm ²	1/(9.806 65 · 10 ⁴)
			Kilogram-force per square millimetre	kgf/mm ²	1/(9.806 65 · 10 ⁶)
Pressure	Pascal (Newton per square metre)	Pa (N/m ²)	Kilogram-force per square metre	kgf/m ²	1/9.806 65
			Water Column	mH ₂ O	1/(9.806 65 · 10 ³)
			Mercury Column	mmHg	760/(1.013 25 · 10 ⁵)
			Torr	Torr	760/(1.013 25 · 10 ⁵)
			Bar	bar	10 ⁵
Atmosphere	atm	1/(1.013 25 · 10 ⁵)			

Conversion factors from SI units (continued)

Parameter	SI Unit		Unit other than SI		Conversion factor from SI unit
	Names of unit	Symbol	Name of unit	Symbol	
Energy	Joule (Newton · metre)	J (N · m)	Erg	erg	107
			Calorie (International)	cal _{IT}	4.186 8
			Kilogram-force metre	kgf · m	1/9.806 65
			Kilowatt hour	kW · h	1/(3.6 · 10 ⁶)
			Metric horse power hour	PS · h	≈ 3.776 72 · 10 ⁻⁷
Power	Watt (Joule per second)	W (J/s)	Kilogram-force metre per second	kgf · m/s	1/9.806 65
			Kilocalorie per hour	kcal/h	1/1.163
			Metric horse power	PS	≈ 1/735.498 8
Dynamic Viscosity	Pascal second	Pa · s	Poise	P	10
Kinematic Viscosity	Square metre per second	m²/s	Stokes	St	10 ⁴
			Centistokes	cSt	10 ⁶
Temperature	Kelvin, Degree celsius	K, °C	Degree	°C	(See note (1))
Electric Current	Ampere	A	Ampere	A	1
Magnetomotive Force					
Voltage, Electromotive Force	Volt	V	(Watts per ampere)	(W/A)	1
Magnetic Field Strength	Ampere per metre	A/m	Oersted	Oe	4π/10 ³
Magnetic Flux Density	Tesla	T	Gauss	Gs	10 ⁴
			Gamma	γ	10 ⁹
Electrical Resistance	Ohm	Ω	(Volts per ampere)	(V/A)	1

Note (1) The conversion from T(K) into θ(°C) is θ = T - 273.15 but for a temperature difference, it is ΔT = Δθ. However, ΔT and Δθ represent temperature differences measured using the Kelvin and Celsius scales respectively.

Remarks The names and symbols in () are equivalent to those directly above them or on their left.

Example of conversion 1N=1/9.806 65kgf

Prefixes used in SI system

Multiples	Prefix	Symbols	Multiples	Prefix	Symbols
10 ¹⁸	Exa	E	10 ⁻¹	Deci	d
10 ¹⁵	Peta	P	10 ⁻²	Centi	c
10 ¹²	Tera	T	10 ⁻³	Milli	m
10 ⁹	Giga	G	10 ⁻⁶	Micro	μ
10 ⁶	Mega	M	10 ⁻⁹	Nano	n
10 ³	Kilo	k	10 ⁻¹²	Pico	p
10 ²	Hecto	h	10 ⁻¹⁵	Femto	f
10 ¹	Deca	da	10 ⁻¹⁸	Atto	a

Inch		11	12	13	14	15	16	17	18	19	20
Fraction	Decimal	mm									
0	0.0000	279.400	304.800	330.200	355.600	381.000	406.400	431.800	457.200	482.600	508.000
1/16	0.0625	280.988	306.388	331.788	357.188	382.588	407.988	433.388	458.788	484.188	509.588
1/8	0.1250	282.575	307.975	333.375	358.775	384.175	409.575	434.975	460.375	485.775	511.175
3/16	0.1875	284.162	309.562	334.962	360.362	385.762	411.162	436.562	461.962	487.362	512.762
1/4	0.2500	285.750	311.150	336.550	361.950	387.350	412.750	438.150	463.550	488.950	514.350
5/16	0.3125	287.338	312.738	338.138	363.538	388.938	414.338	439.738	465.138	490.538	515.938
3/8	0.3750	288.925	314.325	339.725	365.125	390.525	415.925	441.325	466.725	492.125	517.525
7/16	0.4375	290.512	315.912	341.312	366.712	392.112	417.512	442.912	468.312	493.712	519.112
1/2	0.5000	292.100	317.500	342.900	368.300	393.700	419.100	444.500	469.900	495.300	520.700
9/16	0.5625	293.688	319.088	344.488	369.888	395.288	420.688	446.088	471.488	496.888	522.288
5/8	0.6250	295.275	320.675	346.075	371.475	396.875	422.275	447.675	473.075	498.475	523.875
11/16	0.6875	296.862	322.262	347.662	373.062	398.462	423.862	449.262	474.662	500.062	525.462
3/4	0.7500	298.450	323.850	349.250	374.650	400.050	425.450	450.850	476.250	501.650	527.050
13/16	0.8125	300.038	325.438	350.838	376.238	401.638	427.038	452.438	477.838	503.238	528.638
7/8	0.8750	301.625	327.025	352.425	377.825	403.225	428.625	454.025	479.425	504.825	530.225
15/16	0.9375	303.212	328.612	354.012	379.412	404.812	430.212	455.612	481.012	506.412	531.812

Inch		21	22	23	24	25	26	27	28	29	30
Fraction	Decimal	mm									
0	0.0000	533.400	558.800	584.200	609.600	635.000	660.400	685.800	711.200	736.600	762.000
1/16	0.0625	534.988	560.388	585.788	611.188	636.588	661.988	687.388	712.788	738.188	763.588
1/8	0.1250	536.575	561.975	587.375	612.775	638.175	663.575	688.975	714.375	739.775	765.175
3/16	0.1875	538.162	563.562	588.962	614.362	639.762	665.162	690.562	715.962	741.362	766.762
1/4	0.2500	539.750	565.150	590.550	615.950	641.350	666.750	692.150	717.550	742.950	768.350
5/16	0.3125	541.338	566.738	592.138	617.538	642.938	668.338	693.738	719.138	744.538	769.938
3/8	0.3750	542.925	568.325	593.725	619.125	644.525	669.925	695.325	720.725	746.125	771.525
7/16	0.4375	544.512	569.912	595.312	620.712	646.112	671.512	696.912	722.312	747.712	773.112
1/2	0.5000	546.100	571.500	596.900	622.300	647.700	673.100	698.500	723.900	749.300	774.700
9/16	0.5625	547.688	573.088	598.488	623.888	649.288	674.688	700.088	725.488	750.888	776.288
5/8	0.6250	549.275	574.675	600.075	625.475	650.875	676.275	701.675	727.075	752.475	777.875
11/16	0.6875	550.862	576.262	601.662	627.062	652.462	677.862	703.262	728.662	754.062	779.462
3/4	0.7500	552.450	577.850	603.250	628.650	654.050	679.450	704.850	730.250	755.650	781.050
13/16	0.8125	554.038	579.438	604.838	630.238	655.638	681.038	706.438	731.838	757.238	782.638
7/8	0.8750	555.625	581.025	606.425	631.825	657.225	682.625	708.025	733.425	758.825	784.225
15/16	0.9375	557.212	582.612	608.012	633.412	658.812	684.212	709.612	735.012	760.412	785.812

Inch		31	32	33	34	35	36	37	38	39	40
Fraction	Decimal	mm									
0	0.0000	787.400	812.800	838.200	863.600	889.000	914.400	939.800	965.200	990.600	1016.000
1/16	0.0625	788.988	814.388	839.788	865.188	890.588	915.988	941.388	966.788	992.188	1017.588
1/8	0.1250	790.575	815.975	841.375	866.775	892.175	917.575	942.975	968.375	993.775	1019.175
3/16	0.1875	792.162	817.562	842.962	868.362	893.762	919.162	944.562	969.962	995.362	1020.762
1/4	0.2500	793.750	819.150	844.550	869.950	895.350	920.750	946.150	971.550	996.950	1022.350
5/16	0.3125	795.338	820.738	846.138	871.538	896.938	922.338	947.738	973.138	998.538	1023.938
3/8	0.3750	796.925	822.325	847.725	873.125	898.525	923.925	949.325	974.725	1000.125	1025.525
7/16	0.4375	798.512	823.912	849.312	874.712	900.112	925.512	950.912	976.312	1001.712	1027.112
1/2	0.5000	800.100	825.500	850.900	876.300	901.700	927.100	952.500	977.900	1003.300	1028.700
9/16	0.5625	801.688	827.088	852.488	877.888	903.288	928.688	954.088	979.488	1004.888	1030.288
5/8	0.6250	803.275	828.675	854.075	879.475	904.875	930.275	955.675	981.075	1006.475	1031.875
11/16	0.6875	804.862	830.262	855.662	881.062	906.462	931.862	957.262	982.662	1008.062	1033.462
3/4	0.7500	806.450	831.850	857.250	882.650	908.050	933.450	958.850	984.250	1009.650	1035.050
13/16	0.8125	808.038	833.438	858.838	884.238	909.638	935.038	960.438	985.838	1011.238	1036.638
7/8	0.8750	809.625	835.025	860.425	885.825	911.225	936.625	962.025	987.425	1012.825	1038.225
15/16	0.9375	811.212	836.612	862.012	887.412	912.812	938.212	963.612	989.012	1014.412	1039.812

Temperature conversion tables

Appendix table 4 °C-°F conversion table

(Method of using this table) For example, to convert 38°C into °F, read the figure in the right °F column adjacent to the 38 in the center column in the 2nd block. This means that 38°C is 100.4°F. To convert 38°F into°C, read the figure in the left °C column of the same row, which indicates that the answer is 3.3°C.

$$C = \frac{5}{9} (F-32)$$

$$F = 32 + \frac{5}{9} C$$

°C		°F
-73.3	-100	-148.0
-62.2	-80	-112.0
-51.1	-60	-76.0
-40.0	-40	-40.0
-34.4	-30	-22.0
-28.9	-20	-4.0
-23.3	-10	14.0
-17.8	0	32.0
-17.2	1	33.8
-16.7	2	35.6
-16.1	3	37.4
-15.6	4	39.2
-15.0	5	41.0
-14.4	6	42.8
-13.9	7	44.6
-13.3	8	46.4
-12.8	9	48.2
-12.2	10	50.0
-11.7	11	51.8
-11.1	12	53.6
-10.6	13	55.4
-10.0	14	57.2
-9.4	15	59.0
-8.9	16	60.8
-8.3	17	62.6
-7.8	18	64.4
-7.2	19	66.2
-6.7	20	68.0
-6.1	21	69.8
-5.6	22	71.6
-5.0	23	73.4
-4.4	24	75.2
-3.9	25	77.0
-3.3	26	78.8
-2.8	27	80.6
-2.2	28	82.4
-1.7	29	84.2
-1.1	30	86.0
-0.6	31	87.8

°C		°F
0.0	32	89.6
0.6	33	91.4
1.1	34	93.2
1.7	35	95.0
2.2	36	96.8
2.8	37	98.6
3.3	38	100.4
3.9	39	102.2
4.4	40	104.0
5.0	41	105.8
5.6	42	107.6
6.1	43	109.4
6.7	44	111.2
7.2	45	113.0
7.8	46	114.8
8.3	47	116.6
8.9	48	118.4
9.4	49	120.2
10.0	50	122.0
10.6	51	123.8
11.1	52	125.6
11.7	53	127.4
12.2	54	129.2
12.8	55	131.0
13.3	56	132.8
13.9	57	134.6
14.4	58	136.4
15.0	59	138.2
15.6	60	140.0
16.1	61	141.8
16.7	62	143.6
17.2	63	145.4
17.8	64	147.2
18.3	65	149.0
18.9	66	150.8
19.4	67	152.6
20.0	68	154.4
20.6	69	156.2
21.1	70	158.0

°C		°F
21.7	71	159.8
22.2	72	161.6
22.8	73	163.4
23.3	74	165.2
23.9	75	167.0
24.4	76	168.8
25.0	77	170.6
25.6	78	172.4
26.1	79	174.2
26.7	80	176.0
27.2	81	177.8
27.8	82	179.6
28.3	83	181.4
28.9	84	183.2
29.4	85	185.0
30.0	86	186.8
30.6	87	188.6
31.1	88	190.4
31.7	89	192.2
32.2	90	194.0
32.8	91	195.8
33.3	92	197.6
33.9	93	199.4
34.4	94	201.2
35.0	95	203.0
35.6	96	204.8
36.1	97	206.6
36.7	98	208.4
37.2	99	210.2
37.8	100	212.0
38.3	101	213.8
38.9	102	215.6
39.4	103	217.4
40.0	104	219.2
40.6	105	221.0
41.1	106	222.8
41.7	107	224.6
42.2	108	226.4
42.8	109	228.2

°C		°F
43.3	110	230
46.1	115	239
48.9	120	248
51.7	125	257
54.4	130	266
57.2	135	275
60.0	140	284
65.6	150	302
71.1	160	320
76.7	170	338
82.2	180	356
87.8	190	374
93.3	200	392
98.9	210	410
104.4	220	428
110.0	230	446
115.6	240	464
121.1	250	482
148.9	300	572
176.7	350	662
204	400	752
232	450	842
260	500	932
288	550	1022
316	600	1112
343	650	1202
371	700	1292
399	750	1382
427	800	1472
454	850	1562
482	900	1652
510	950	1742
538	1000	1832
593	1100	2012
649	1200	2192
704	1300	2372
760	1400	2552
816	1500	2732
871	1600	2912

Notes



A series of horizontal lines for writing notes, consisting of approximately 25 evenly spaced lines.

Notes



A series of 22 horizontal lines for writing notes, spaced evenly down the page.



NSK Sales Offices – Europe, Middle East and Africa

UK

NSK UK Ltd.
Northern Road, Newark
Nottinghamshire NG24 2JF
Tel. +44 (0) 1636 605123
Fax +44 (0) 1636 643276
info-uk@nsk.com

France

NSK France S.A.S.
Quartier de l'Europe
2, rue Georges Guynemer
78283 Guyancourt Cedex
Tel. +33 (0) 1 30573939
Fax +33 (0) 1 30570001
info-fr@nsk.com

Germany, Austria, Switzerland, Benelux, Nordic

NSK Deutschland GmbH
Harkortstraße 15
40880 Ratingen
Tel. +49 (0) 2102 4810
Fax +49 (0) 2102 4812290
info-de@nsk.com

Italy

NSK Italia S.p.A.
Via Garibaldi, 215
20024 Garbagnate
Milanese (MI)
Tel. +39 02 995 191
Fax +39 02 990 25 778
info-it@nsk.com

Middle East

NSK Bearings Gulf Trading Co.
JAFZA View 19, Floor 24 Office 2/3
Jebel Ali Downtown,
PO Box 262163
Dubai, UAE
Tel. +971 (0) 4 804 8205
Fax +971 (0) 4 884 7227
info-me@nsk.com

Poland & CEE

NSK Polska Sp. z o.o.
Warsaw Branch
Ul. Migdałowa 4/73
02-796 Warszawa
Tel. +48 22 645 15 25
Fax +48 22 645 15 29
info-pl@nsk.com

South Africa

NSK South Africa (Pty) Ltd.
27 Galaxy Avenue
Linbro Business Park
Sandton 2146
Tel. +27 (011) 458 3600
Fax +27 (011) 458 3608
nsk-sa@nsk.com

Spain

NSK Spain, S.A.
C/ Tarragona, 161 Cuerdo Bajo
2ª Planta, 08014 Barcelona
Tel. +34 93 2892763
Fax +34 93 4335776
info-es@nsk.com

Turkey

NSK Rulmanları Orta Doğu Tic. Ltd. Şti
Cevizli Mah. D-100 Güney Yan Yol
Kuriş Kule İş Merkezi No:2 Kat:4
34846 Cevizli - Kartal - İstanbul
Tel. +90 216 4777111
Fax +90 216 4777174
turkey@nsk.com

Please also visit our website: www.nskurope.com | Global NSK: www.nsk.com

